

# OMRON

## Safety Edge/ Edge Controller

### SGE/SCC

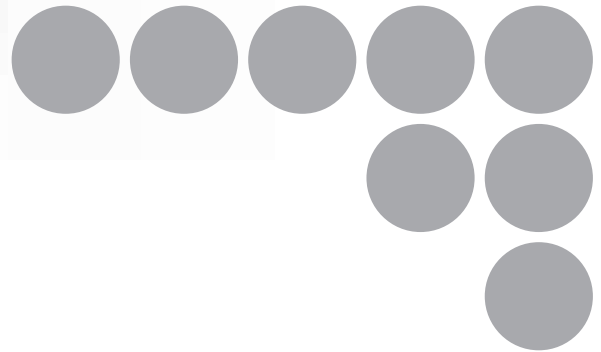

*Introducing the New Safety Edge  
- Friendly to Human and Machines*



realizing

# EDGE

## SAFETY EDGE & EDGE CONTROLLER



SGE  
Safety Edge



SCC  
Edge Controller

### Introducing the New Safety Edge - Friendly to Human and Machines

The SGE Safety Edge, mounted to moving parts such as doors and fences of mechanical equipment, will stop hazards from moving parts or undergo a complete system shutdown upon detection of contact with persons or objects. Its elastic material and shock absorption properties soften the impact on such persons or objects. The SCC Edge Controller conforms to PLd/Safety Category 3. Occurrence of any short-circuits and/or breaks are continually monitored and the status shown with LED indicators.

## APPLICATION Protecting people in such areas like:

### Shutter Door

The Safety Edge mounted to the end of a shutter door stops the downside movement of the shutter to prevent shearing of a person or object when it detects a contact with them.



### Protective Door of a Processing Machine

The Safety Edge, mounted to the moving part of a protective door, will stop door movement to prevent jamming of persons or objects upon detection of contact with them.



### Reciprocating Table of a Machine Tool

The Safety Edge, mounted to the moving part of a reciprocating table, will stop the table's movement to prevent collision with the moving part or jamming between the moving part and structures such as walls or poles upon detection of contact with workers.



# SAFETY EDGE & EDGE CONTROLLER

## Extensive Lineup

We have prepared a lineup, tailor-made to fit with your devices and applications.

- **Sensor length**  
150 to 6,100 mm  
(in 50 mm increments)
- **Height**  
34 to 80 mm in five series



When using applications that require increased water resistance, please use models that give sealing covers.

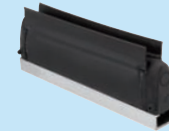

SGE-245L

## Easy to Order & Assembly Free

By covering just 4 points, a ready-to-use Safety Edge will be delivered to you:



### Shape

Select a shape from five series as required in your application or equipment



POINT  
1

### Wiring

Select wiring from four types (2-wire/connector (male/female) cable, terminating resistor) and cable length 100 mm or any length from 500 mm to 10,000 mm with increments of 500 mm for both ends of the Safety Edge.

POINT  
2

### Length

Select any length from 150 mm to 6,100 mm with increments of 50 mm.

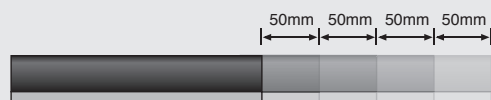

POINT  
3

### Mounting base

An L-shaped mounting base is also provided depending on the mounting location (except the SGE-125 series)

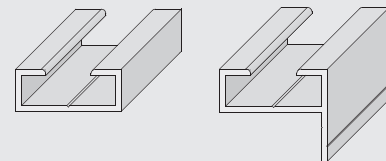

POINT  
4

Note: For details, refer to "Model Number Structure" on page 4 or later.

## SCC Edge Controller

Dedicated SCC Edge Controller that regulates a system conforming to Safety Category 3.



- Dedicated SCC Edge Controller enables establishment of a safety system conforming to PLd/Safety Category 3 (when hazards are directly blocked by built-in relays)
- Any short-circuits or breaks in the system are monitored and its status is indicated with LED.
- Authenticated under major safety standards

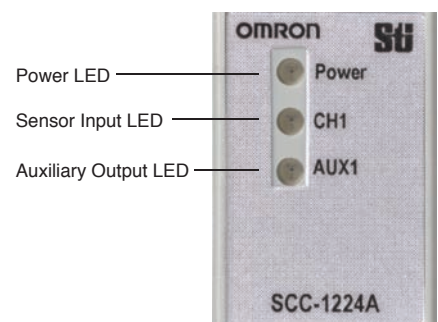

**NEW**

Note: For details on LED indicators, refer to "Connection" on page 13.

# Safety Edge/Edge Controller

# SGE/SCC

## Safety sensors to detect contacts by mounting to moving parts of hazards



- Conforms to PLd/Safety Category 3 in combination with the dedicated controller.  
(applied when internal relays with forcibly guided contacts disable hazard source directly)
- Simple one-unit structure integrating sensor and cover.
- Resistant to the side force.
- Can be used in various applications.  
Sensor length: 150 mm to 6,100 mm, Height: 34 mm to 80 mm
- Models with sealing covers for doors are provided (SGE-245L).
- Certified standard: EN ISO 13856-2 (Safety Edge Standard)



 Be sure to read the "Safety Precautions" on page 20.

## Model Number Structure

### Ordering process

SGE series safety edges are custom order products according to customer's equipment or application. Select a product and specifications as shown in the following steps, and contact your OMRON representative.

### Step 1. Models

Select a cross-sectional shape of a safety edge (sensor).  
Select the most appropriate model to the equipment used, considering actuation distance (amount of compression required from an application of pressure to the safety edge to detection), and actuation force (compression force at the actuation distance).  
Five series with different cross-sectional shapes are provided.

Code	125	225	245	245L	365
Model	SGE-125	SGE-225 *2	SGE-245	SGE-245L	SGE-365
Shape					
Actuation distance *1	2.6 mm	3.9 mm	7.4 mm		5.2 mm
Actuation force *1	42 N	57 N	68 N		78 N

\*1. Values of actuation distance and actuation force are characteristic values tested according to EN ISO 13856-2 using a test object of  $\phi 80$  mm and actuating point C3 under a test temperature of 20°C and test speed  $v = 10$  mm/s. Refer to "Characteristics" on page 12 for details.

\*2. The SGE-225 can be used for finger protection. The actuation force is 20 N when the SGE-225 is used for finger protection.  
(Characteristic values tested according to EN ISO 13856-2 using a test object of  $\phi 20$  mm and actuating point C3 under a test temperature of 20°C and test speed  $v = 10$  mm/s)

**Note:** 1. For the differences in characteristics, refer to "Specifications" on page 9.  
2. Models with sealing cover to reduce liquid splash to the inside and outside of the door are available (SGE-245L). These models can be used in applications where sensors are installed on moving doors of machines.

## Step 2. Wiring Configuration and Cable Termination

Determine a wiring configuration according to the number of safety edges (sensor) in series. (Up to 5 safety edges can be connected in series.) There are five types of cable termination for both ends of the safety edge. The method can be selected from the combinations of 2-wire cable, cable with M8 connector (male or female), and terminating resistor as shown below.

Configuration No.	Outline drawing	Wiring configuration and cable termination
0		2-wire cable on both sides
2		2-wire cable on one side, terminating resistor on the other side (8.2kΩ 0.25W) *
3		Connector cable on one side (male), connector cable on the other side (female)
4		Connector cable on one side (male), terminating resistor on the other side (8.2kΩ 0.25W) *
5		2-wire cable on one side, connector cable on the other side (female)

**Note:** 1. To connect safety edges in series, two types of methods are available: Using a 2-wire cable or M8 connector.

2. To connect with an edge controller, a 2-wire cable should be used. There is no polarity.

\* When using one safety edge, use Configuration No. 2.

When connecting safety edges in series, use Configuration No. 2 or Configuration No. 4 with a built-in terminating resistor for the last series-connected safety edge.

See the configuration example below for more information.

### Configuration Example

#### Using one safety edge (Configuration No. 2 × 1)

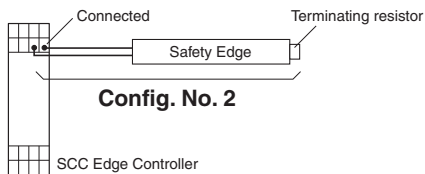

#### Using two safety edges

##### Connecting using 2-wire cables

(Config. No. 0 × 1) + (Config. No. 2 × 1)

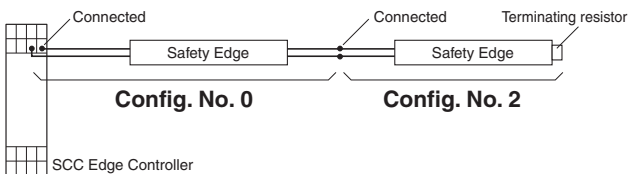

##### Connecting using connectors

(Config. No. 5 × 1) + (Config. No. 4 × 1)

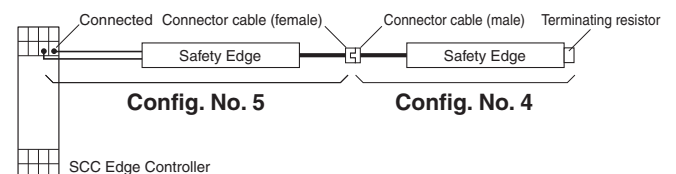

#### Using N safety edges

##### Connecting using 2-wire cables

(Config. No. 0 × (N - 1)) + (Config. No. 2 × 1)

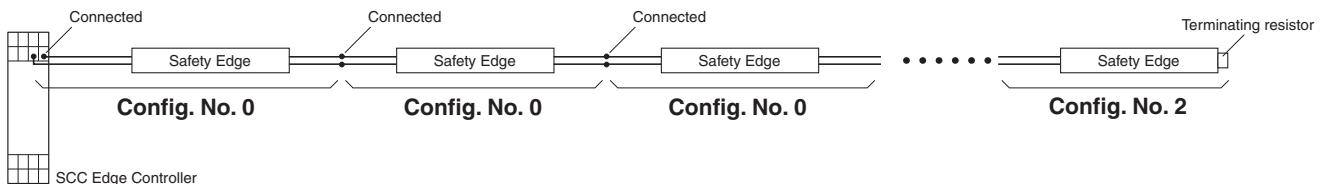

##### Connecting using connectors

(Config. No. 5 × 1) + (Config. No. 3 × (N - 2)) + (Config. No. 4 × 1)

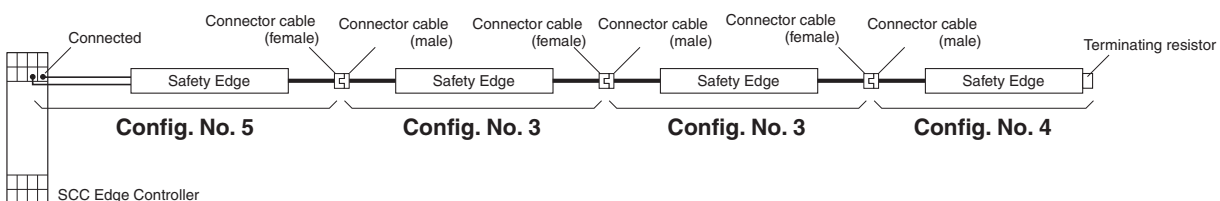

### Step 3. Sensor Length

Determine the length of a safety edge.

Choose any length from **0150** mm\* to **6100** mm with increments of 50 mm.

\* When the length is less than 1,000 mm, zero "0" is added on the top of the number to make it four digits.

- Note:**
1. The user cannot cut the safety edge.
  2. For other lengths, contact your OMRON representative.

### Step 4. Mounting Base

Aluminum base is used to mount a safety edge (sensor) to equipment. Select one from the following.

Model	SGE-125		SGE-225/245		SGE-365	
Code	None		None	L	None	
Shape						

**Note:** A base with more than 1.2 m is cut and split before delivery as shown below.

Sensor length = LEN (mm)	Mounting base cut length (mm)	No. of split bases
0150 to 1200	LEN	1
1210 to 2400	1/2 LEN	2
2410 to 3600	1/3 LEN	3
3610 to 4800	1/4 LEN	4
4810 to 6000	1/5 LEN	5
6010 to 6100	1/6 LEN	6

(Example) When the sensor length LEN is 2,700 mm, three 900 mm mounting bases will be provided.

### Step 5. Cable Length and Cable Termination

Determine the cable length of both ends of the safety edge.

Choose **00100** mm length or any length from **00500** mm to **10000** mm with increments of 500 mm.

- Note:**
1. For internal terminal resistor side, there is no cable. Cable length is not specified.
  2. Code length is indicated by five digits. Add 00 on the top the number for 100 mm or more and less than 1,000 mm, add 0 for 1,000 mm or more and less than 10,000 mm.
  3. For other lengths, contact your OMRON representative.

Determine the cable termination method for both ends of a safety edge and add a code at the end of the cable length.

Code	Specification
<b>C</b>	2-wire cable
<b>M</b>	Connector cable (male)
<b>F</b>	Connector cable (female)

**Note:** When using a terminating resistor, cable termination method is not required to be selected.

### Step 6. Direction of Cable Connection

Determine the direction of the cable that is connected to the Safety Edge.

Code	Direction of Cable Connection	
	SGE-125	SGE-225 SGE-245(L) SGE-365
<b>None</b>	The cables are connected to the right side of the Safety Edge. 	The cables are connected to the bottom of the Safety Edge. 
<b>R</b>	---	The cables are connected to the right side of the Safety Edge. 
<b>L</b>	The cables are connected to the left side of the Safety Edge. 	The cables are connected to the left side of the Safety Edge. 

**Note:** Refer to "Model Number Legend" for 5 and 6 in the above table.

Orders can be customized by selecting items from Step 1 to 6. Also see "Model Number Legend" on the following page.



## Model Number Legend

### Safety Edge

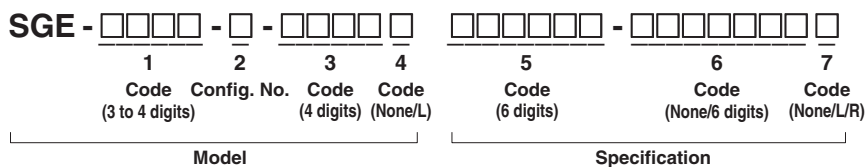

### 1. Type

Code	Cross-section dimensions (including standard mounting base) *
125	15 mm × 34 mm
225	25 mm × 39 mm
245	25 mm × 60 mm
245L	25 mm × 74 mm (including sealing cover)
365	35 mm × 80 mm

\* For dimensions including L-shaped base, refer to "Dimensions/ Terminal Arrangement" on page 15.

### 2. Wiring Configuration and Cable Termination

Configuration No.	Specification
0	2-wire cable on both sides
2	2-wire cable on one side, terminating resistor on the other side
3	Connector cable on one side (male), connector cable on the other side (female)
4	Connector cable on one side (male), terminating resistor on the other side
5	2-wire cable on one side, connector cable on the other side (female)

### 3. Sensor Length

Code	Specification
4-digit number	0150 to 6,100 mm (in increments of 50 mm)

### 4. Mounting Base

Code	Specification
None	Standard Mounting Base
L	L-shaped Mounting Base

Note: Only the Standard Mounting Base is available for the SGE-125.

### 5 and 6. Cable Length and Cable Termination

When the configuration number of "2" is 2 or 4, specify "5" only, when it is 0, 3, or 5, specify "5" and "6" (on account of cable termination on both sides).

Terminal code C: 2-wire cable M: Connector cable (male) F: Connector cable (female)

Config. No. of 2	5		6	
	Cable Length * (5 digits)	Terminal code	Cable Length * (5 digits)	Terminal code
0	00100 to 10000	C	00100 to 10000	C
2	00100 to 10000	C	Terminating resistor	None
3	00100 to 10000	M	00100 to 10000	F
4	00100 to 10000	M	Terminating resistor	None
5	00100 to 10000	C	00100 to 10000	F

\* Choose 100 mm length or any length from 500 mm to 10,000 mm with increments of 500 mm.

### 7. Direction of Cable Connection

Code	Direction of Cable Connection	
	SGE-125	Other models
None	Right (standard)	Bottom (standard)
R	–	Right
L	Left	Left

### Edge Controller

## SCC-1224A

### Selection Example 1

SGE-225-2-1500 500C

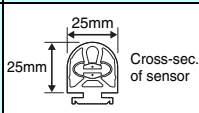
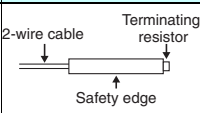
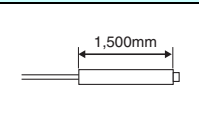
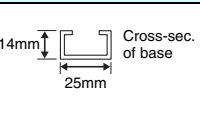
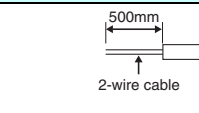
Sequence	Step 1	Step 2	Step 3	Step 4	Step 5
Location					
Category	1. Type	2. Config. No.	3. Sensor Length	4. Mounting Base	5. Cable Length and Cable Termination
Code/Config. No.	225	2	1500	None	00500C

### Selection Example 2

SGE-245-5-0700L 01000C-00500F

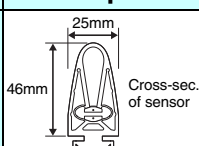
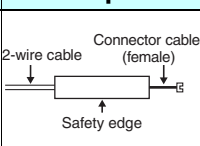
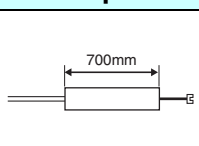
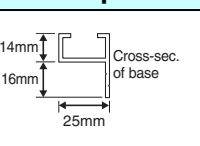
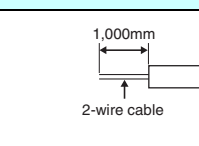
Sequence	Step 1	Step 2	Step 3	Step 4	Step 5
Location					
Category	1. Type	2. Config. No.	3. Sensor Length	4. Mounting Base	5. Cable Length and Cable Termination
Code/Config. No.	245	5	0700	L	01000C 00500F

# SGE/SCC

## Ordering Information

### Edge Controller

Product	Appearance	Safety output	Auxiliary output	Rated voltage	Terminal block type	Model
Safety Mat/ Edge Controller *	 <b>NEW</b>	SPDT-NO	SPST-NO	120 VAC or 24 VAC/DC	Screw terminals	<b>SCC-1224A</b>

\* Can also be connected with UMA-series Safety Mats.





Refer to the *SCC-1224A Safety Mat/Edge Controller User Manual* (Cat. No. Z394) for details.

Product	Appearance	Safety output	Auxiliary output	Rated voltage	Terminal block type	Model
Edge Controller		DPST-NO	SPST-NO *1	24 VDC	Screw terminals	<b>SCC-1224</b>
			SPST-NO *2			<b>SCC-1224ND</b>

\*1. One-shot timer that turns ON between two and three seconds after the application of pressure to the safety edge

\*2. Kept ON during the application of pressure to the safety edge

### Safety Edge

Appearance	Cross-sectional dimensions (including a standard mounting base) * 1	Actuation distance * 2	Material	Model	Specification (Cable)
	15 mm × 34 mm	2.6 mm	TPE	<b>SGE-125-□-□</b>	□ (-□)
	25 mm × 39 mm	3.9 mm	EPDM	<b>SGE-225-□-□ (L)</b>	□ (-□)
	25 mm × 60 mm	7.4 mm		<b>SGE-245-□-□ (L)</b>	□ (-□)
	25 mm × 60 mm 25 mm × 74 mm (including sealing cover)			<b>SGE-245L-□-□ (L)</b>	□ (-□)
	35 mm × 80 mm	5.2 mm		<b>SGE-365-□-□ (L)</b>	□ (-□)

\*1. For dimensions including L-shaped base, refer to "Dimensions/Terminal Arrangement" on page 15.

\*2. Values of actuation distance are characteristic values tested according to EN ISO 13856-2 using a test object of φ80 mm and actuating point C3 under a test temperature of 20°C and test speed v = 10 mm/s. Refer to "Characteristics" on page 11 for details.



## Specifications

### Edge Controller SCC-1224A

#### Power Input

<b>Power supply voltage*</b>	120 VAC 50/60Hz (Terminals A1 and A2) 24 VAC 50/60Hz or 24 VDC (Terminals B1 and B2)
<b>Operating voltage range</b>	-10% to +10% of rated power supply voltage
<b>Power consumption (with sensors connected)</b>	120 VAC: 3.8 VA max. 50 Hz, 3.5 VA max. 60 Hz 24 VAC: 1.2 VA max., 24 VDC: 1.5 W max.

\*Select either Terminals A1 and A2 or Terminals B1 and B2 according to the power supply voltage applied. Never apply both voltages simultaneously.

#### Inputs

<b>Sensor input</b>	SGE Safety Edge: A maximum of 5 edges can be connected in series. Maximum wiring length: 25 m max.
---------------------	---

#### Contacts

<b>Safety output</b>	230 VAC 3 A, 24 VDC 3 A (resistive load) 230 VAC 1 A (AC-15), 24 VDC 2 A (DC-13) (inductive load)
<b>Auxiliary output</b>	24 VAC/DC 2A (resistive load)

#### Characteristics

<b>Startup time *1</b>	300 ms max.	
<b>Operating time (Open to closed) *2</b>	550 ms max.	
<b>Response time (Closed to open) *3</b>	13 ms max.	
<b>Vibration resistance</b>	Malfunction: 10 to 55 Hz, Sinus, 0.15 mm amplitude, 10 cycles	
<b>Shock resistance</b>	Malfunction: 147 m/s <sup>2</sup>	
<b>Durability</b>	<b>Mechanical</b>	1,000,000 cycles min.
	<b>Electrical</b>	AC-15: 800,000 cycles min. (230 VAC, 1A) DC-13: 250,000 cycles min. (24 VDC, 2A)
<b>Ambient operating temperature</b>	-20 to 55°C (-4 to 131°F) (with no icing or condensation)	
<b>Ambient operating humidity</b>	0% to 90%	
<b>Degree of protection</b>	IP20	
<b>Material (Housing)</b>	Polyamide PA6.6, self-extinguishing according to UL 94-V2	
<b>Protection type</b>	Class II (protective insulation)	
<b>Pollution degree</b>	2	
<b>Overvoltage category (IEC/EN 60664-1)</b>	III	
<b>Rated insulation voltage</b>	250 V	
<b>Rated impulse voltage resistance</b>	4 kV	
<b>Dielectric strength</b>	1.5 kVAC	
<b>Terminal tightening torque</b>	0.5 to 0.6 N•m	
<b>Weight</b>	approx. 210 g (7.4 oz)	
<b>Conformity</b>	<b>Conforming to Standards</b>	EN ISO 13856-2, EN ISO 13849-1: 2015, EN 61000-6-2, EN 61000-6-3, ANSI/UL 508, CSA C22.2 No.14
	<b>PFHd</b>	6.5×10 <sup>-9</sup> (Nop 17,520)
	<b>MTTFd</b>	195 years
	<b>DC</b>	99% (Nop 17,520)

\*1. The startup time is the delay time from power-on to when the SCC-1224A Safety Mat/Edge Controller is ready to operate.

\*2. The operating time is the time it takes for the safety output contacts to be closed after the sensor is deactivated and the manual reset input contacts are closed. The contact bounce time is not included.

\*3. The response time is the time it takes for the safety output contacts to open after the sensor is activated. Contact bounce time is included.

**Note:** The SCC-1224/SCC-1224ND have different specifications. Consult your OMRON representative for details.

## Safety Edge

Item	Model	SGE-125	SGE-225 *4	SGE-245 SGE-245L	SGE-365
Material *1		TPE	EPDM		
Material hardness		65 Shore A	68 Shore A		
Max. length of a single safety edge		6.1 m			
Actuation distance *2		2.6 mm	3.9 mm	7.4 mm	5.2 mm
Actuation force *2		42 N	57 N	68 N	78 N
Maximum allowable load		500N			
Overtravel distance *2 (400 N)		9.5 mm	6.7 mm	18.3 mm	33.8 mm
Maximum operation angle		2 x 30°		2 x 45°	
Inactive end region *3		20 mm	40 mm	20 mm	
Connecting cable		2 conductors, 0.34 mm <sup>2</sup> , Allowable bending radius: R38mm Cable Specifications Type : PUR (Polyurethane) Round lead cable External diameter : 3.5 dia. Number of conductors : 2 conductors Cross-section of conducto : 0.34 mm <sup>2</sup> Insulator diameter : 1.2 dia.			
Mechanical durability		10,000 operations min.			
Ambient temperature		During operation: -10 to 55°C (with no icing), During storage: -25 to 75°C (with no icing)			
Operating ambient humidity		0 to 90%RH			
Degree of protection		IP65			
Unit weight		0.18 kg/m	0.51 kg/m	0.77 kg/m (SGE-245) 0.82 kg/m (SGE-245L)	1.10 kg/m

\*1. TPE: Thermoplastic Elastomer

EPDM: Ethylene Propylene Rubber

\*2. Values of actuation distance and actuation force are characteristic values tested according to EN ISO 13856-2 using a test object of  $\phi 80$  mm and actuating point C3 under a test temperature of 20°C and test speed  $v = 10$  mm/s. Refer to "Characteristics" on page 12 for details.

\*3. There is an inactive region (including an end cap) in both ends of the safety edge.

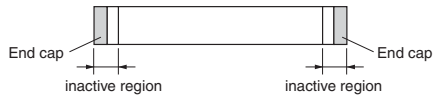

\*4. The SGE-225 can be used for finger protection. The actuation force is 20 N when the SGE-225 is used for finger protection.

(Characteristic values tested according to EN ISO 13856-2 using a test object of  $\phi 20$  mm and actuating point C3 under a test temperature of 20°C and test speed  $v = 10$  mm/s)

**Mechanical Force**

Material	TPE						EPDM					
	SGE-125						SGE-225, SGE-245, SGE-365					
Model	1	2	3	4	5	6	1	2	3	4	5	6
<b>Features Strength #</b>												
<b>Tear Strength (Resistance)</b>			3						3			
<b>Ultimate Tensile Strength</b>			3						3			
<b>Rebound Elasticity at 20°C</b>		2						2				
<b>Resistance Against Permanent Deformation</b>			3	4				2				
<b>Abrasion</b>			3						3			
<b>Elongation at Tear</b>				4	5				3			
<b>Cold Flexibility</b>		2						2				

**Note:** 1 = Excellent  
 2 = Very good  
 3 = Good  
 4 = Fair  
 5 = Poor  
 6 = Very poor

**Environmental Resistance**

Material	TPE						EPDM					
	SGE-125						SGE-225, SGE-245, SGE-365					
Model	1	2	3	4	5	6	1	2	3	4	5	6
<b>Features Tolerance #</b>												
<b>Heat Stability</b>				4				2				
<b>Oxidation Stability</b>	1						1					
<b>UV Stability</b>	1						1					
<b>Weather/Ozone Resistance</b>	1						1					
<b>Flame Resistance</b>						6						6
<b>Gas Permeability</b>			3							4		

**Note:** 1 = Excellent  
 2 = Very good  
 3 = Good  
 4 = Fair  
 5 = Poor  
 6 = Very poor

**Chemical Resistance**

Material	TPE						EPDM					
	SGE-125						SGE-225, SGE-245, SGE-365					
Model	1	2	3	4	5	6	1	2	3	4	5	6
<b>Features Effects #</b>												
<b>Water Resistance</b>	1						1	2				
<b>Diluted Acids</b>	1							2				
<b>Diluted Bases</b>	1							2				
<b>Non-Oxidizing Acids</b>		2						2				
<b>Oxidizing Acids</b>		2								4		
<b>ASTM Oil #3</b>		2										6
<b>Vegetable Oils</b>	1	2										5
<b>Organic Solvents</b>								2				
<b>Ester Solvents</b>		2	3					2				
<b>Ketone Solvents (Containing Oxygen)</b>		2	3						3			
<b>Aliphatic Hydrocarbons Solvents (Gasoline)</b>												5
<b>Aromatic Hydrocarbons</b>												6
<b>Hydrocarbons</b>		2	3									5
<b>Alcohol</b>	1						1					

**Note:** 1 = No Effects, Permanent Contact  
 2 = Few Effects, Some Contact  
 3 = Medium Effects, Some Contact  
 4 = Noticeable Effects, Reduced Contact  
 5 = Severe Effects, Very Brief Contact  
 6 = Extreme Effects, Avoid Contact

# Characteristics

## Force Distance

SGE-225: Characteristic Values for Test Speed  $v = 10 \text{ mm/s}$   
 Test Temperature  $+20^\circ\text{C}$

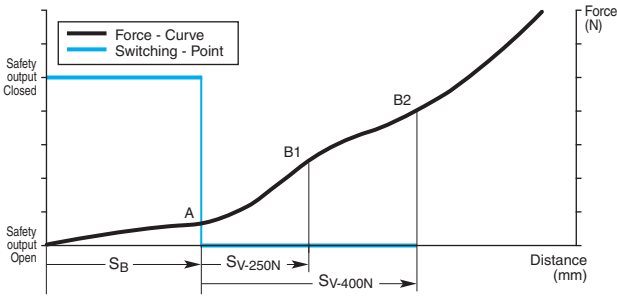

**SGE-125: Characteristic Values for Test Speed  $v = 10 \text{ mm/s}$**

Test Temperature	$+20^\circ\text{C}$
Actuating Force $F_A$ (N)	42
Actuating Distance $S_B$ (mm)	2.6
Overtravel Distance $S_v$ at 250N in mm	8.1
Overtravel Distance $S_v$ at 400N in mm	9.5

**Note:** Tested according to EN ISO 13856-2, test object of  $\phi 80\text{mm}$ , actuating point C3.

**SGE-225: Characteristic Values for Test Speed  $v = 10 \text{ mm/s}$**

Test Temperature	$+20^\circ\text{C}$
Actuating Force $F_A$ (N)	57
Actuating Distance $S_B$ (mm)	3.9
Overtravel Distance $S_v$ at 250N in mm	2.3
Overtravel Distance $S_v$ at 400N in mm	6.7

**Note:** Tested according to EN ISO 13856-2, test object of  $\phi 80\text{mm}$ , actuating point C3.

**SGE-245: Characteristic Values for Test Speed  $v = 10 \text{ mm/s}$**

Test Temperature	$+20^\circ\text{C}$
Actuating Force $F_A$ (N)	68
Actuating Distance $S_B$ (mm)	7.4
Overtravel Distance $S_v$ at 250N in mm	15.8
Overtravel Distance $S_v$ at 400N in mm	18.3

**Note:** Tested according to EN ISO 13856-2, test object of  $\phi 80\text{mm}$ , actuating point C3.

**SGE-365: Characteristic Values for Test Speed  $v = 10 \text{ mm/s}$**

Test Temperature	$+20^\circ\text{C}$
Actuating Force $F_A$ (N)	78
Actuating Distance $S_B$ (mm)	5.2
Overtravel Distance $S_v$ at 250N in mm	29.8
Overtravel Distance $S_v$ at 400N in mm	33.8

**Note:** Tested according to EN ISO 13856-2, test object of  $\phi 80\text{mm}$ , actuating point C3.

**SGE-125: Characteristic Values for Test Speed  $v = 100 \text{ mm/s}$**

Test Temperature	$+20^\circ\text{C}$
Actuating Force $F_A$ (N)	43
Actuating Distance $S_B$ (mm)	6.4
Overtravel Distance $S_v$ at 250N in mm	7.7
Overtravel Distance $S_v$ at 400N in mm	8.6

**Note:** Tested according to EN ISO 13856-2, test object of  $\phi 80\text{mm}$ , actuating point C3.

**SGE-225: Characteristic Values for Test Speed  $v = 100 \text{ mm/s}$**

Test Temperature	$+20^\circ\text{C}$
Actuating Force $F_A$ (N)	63
Actuating Distance $S_B$ (mm)	4.4
Overtravel Distance $S_v$ at 250N in mm	2.7
Overtravel Distance $S_v$ at 400N in mm	7.2

**Note:** Tested according to EN ISO 13856-2, test object of  $\phi 80\text{mm}$ , actuating point C3.

**SGE-245: Characteristic Values for Test Speed  $v = 100 \text{ mm/s}$**

Test Temperature	$+20^\circ\text{C}$
Actuating Force $F_A$ (N)	83
Actuating Distance $S_B$ (mm)	7.8
Overtravel Distance $S_v$ at 250N in mm	15.2
Overtravel Distance $S_v$ at 400N in mm	17.7

**Note:** Tested according to EN ISO 13856-2, test object of  $\phi 80\text{mm}$ , actuating point C3.

**SGE-365: Characteristic Values for Test Speed  $v = 100 \text{ mm/s}$**

Test Temperature	$+20^\circ\text{C}$
Actuating Force $F_A$ (N)	107
Actuating Distance $S_B$ (mm)	6.2
Overtravel Distance $S_v$ at 250N in mm	28.3
Overtravel Distance $S_v$ at 400N in mm	32.7

**Note:** Tested according to EN ISO 13856-2, test object of  $\phi 80\text{mm}$ , actuating point C3.

## Installation

Safety edges must only be installed by authorized persons.

1. To facilitate installation of the safety edge, the mounting base may only be attached to even surfaces. If the safety edge is mounted in a bend, the radius must not be less than the specified minimum.

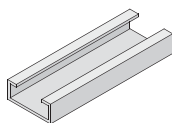

2. The mounting base must be fitted with countersunk screws or rivets. A diameter of 4 mm is sufficient. The holes of 4.5 mm must be evenly distributed over the entire length of the mounting base with distances between them not exceeding 300 mm. They have to be countersunk according to the screw size.

For SGE-225/245 (L-shaped)  
For SGE-365 (L-shaped)

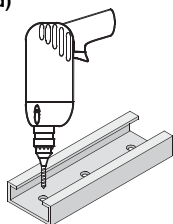

When using SGE-125, drill a pilot hole to the groove such that the head of a countersunk screw can go through (approx. 8 mm).

For SGE-125

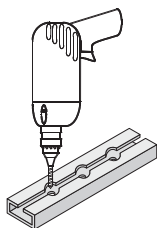

3. Pan- or round-head screws should not be used. Otherwise the connecting wire in the mounting base could be damaged.



4. In order to lead the connecting wire through the mounting base, an 8 mm hole has to be drilled in the appropriate place. Carefully remove the burr from both sides.

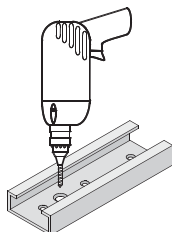

5. The connecting wire and the cable end with the terminal resistor have to be placed in the mounting base.

6. In order to make fitting the safety edge easier, the mounting base and the safety edge should be sprayed with soapy water. Once the soap suds have evaporated, the safety edge is firmly fitted in the aluminum base. To prevent a subsequent slipping of the safety edge, talcum powder, oils or similarly durable lubricants must not be used.

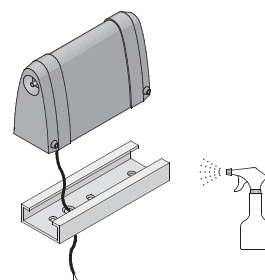

7. Safety edges with a C-base (SGE-365) have to be clipped with one side into the mounting base. Then press in the complete c-base. Pulling or pushing the safety edge into the mounting base can cause damage to the safety edge and should be avoided at all costs.

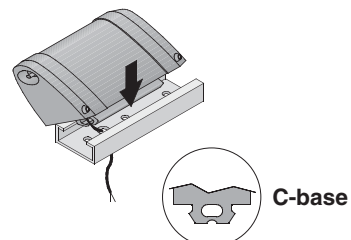

C-base

8. Safety edges with T-bases (SGE-125/-225/-245/-245L) have to be inserted from the side along the groove of the mounting base.

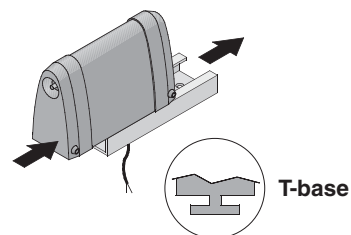

T-base

Any other methods of fastenings are only permitted on prior agreement with the manufacturer.

SCC-1224A

Internal Connection Diagram

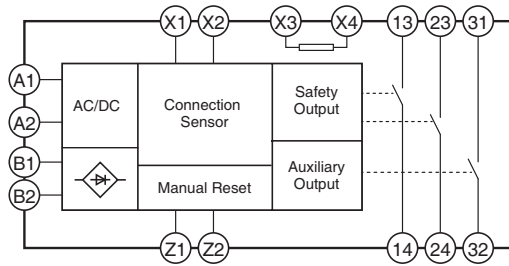

Wiring of Inputs and Outputs

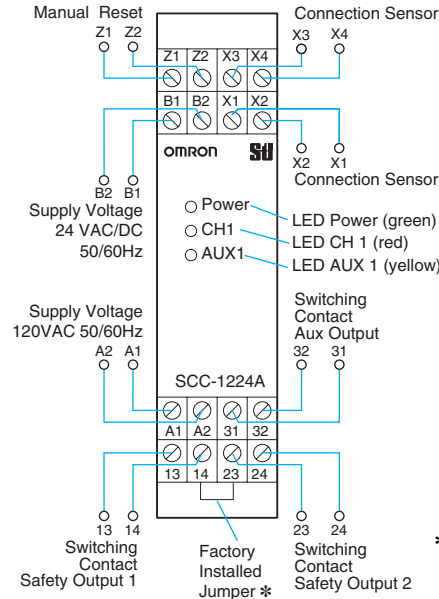

\* Remove the factory-installed jumper between terminals 14 and 23 if safety outputs 1 and 2 are not connected in series.

Terminals

Signal	Terminal	Overview	Wiring
Supply Voltage 120 VAC	A1, A2	Input terminals of 120 VAC supply voltage.	Do not connect a supply voltage of 24 VAC or 24 VDC.
Supply Voltage 24 VAC/DC	B1, B2	Input terminals of 24 VAC or 24 VDC supply voltage.	Do not connect a supply voltage of 120 VAC. When using 24 VDC, connect 24 VDC line to B1 and 0 VDC line to B2.
Connection Sensor	X1, X2 X3, X4	Input terminals of sensor signal.	Connect signal lines of SGE Safety Edge. Do not connect any lines.
Manual Reset	Z1, Z2	Input terminals of a reset switch (NO contact). Also used as external device monitoring (EDM) terminals of contactors.	Do not connect any lines when in the automatic reset mode. Connect NC contacts of contactors when using the external device monitoring (EDM) function.
Safety Output 1	13-14	Closed or open according to sensor and manual reset inputs.	Do not connect any lines when not used. Remove the factory-installed jumper between terminals 14 and 23 if safety outputs 1 and 2 are not connected in series.
Safety Output 2	23-24		
Auxiliary Output	31-32	In the auxiliary output without delay mode, the auxiliary output is closed without delay when the safety outputs are open. In the auxiliary output delayed mode, the auxiliary output is closed with a delay of 0.5 s after the safety outputs are open, and remains closed for 3 s.	Do not connect any lines when not used. Do not use this as safety output.

LEDs

Label	Color	Name	Status	Description
Power	Green	Power LED	ON	Operating state
			Flashing	Fault alarm
CH1	Red	Sensor Input LED	ON	Sensor activated (Safety output OFF)
			Fast flashing (approx. 4 Hz)	Sensor faulty
			Slow flashing (approx. 1 Hz)	Waiting for reset switch input (Safety output OFF)
			OFF	Released from interlocked state (Safety output ON)
AUX1	Yellow	Auxiliary output LED	ON	Auxiliary output contact closed
			OFF	Auxiliary output contact open



# Dimensions/Terminal Arrangement

## Edge Controller

### SCC-1224A

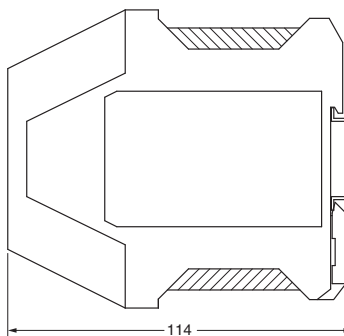
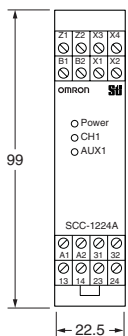

### Terminal Arrangement

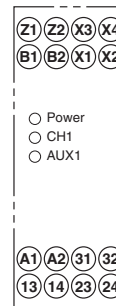

## Safety Edge

### SGE-125

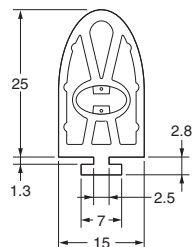

### SGE-225

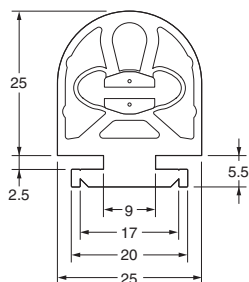

### SGE-245

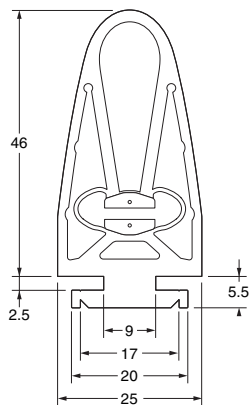

### SGE-245L

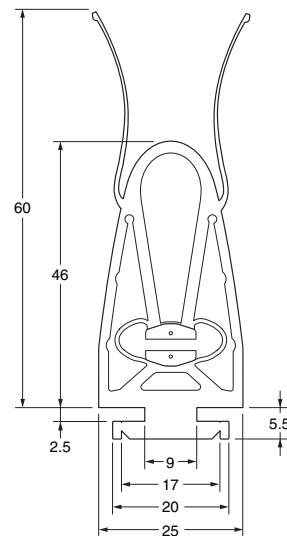

SGE-365

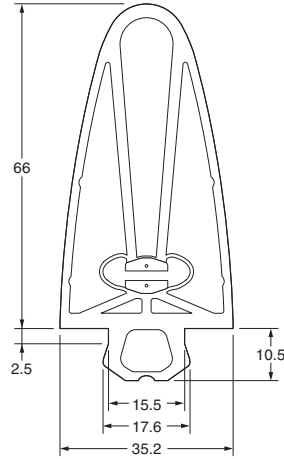

Mounting Bases

For SGE-125

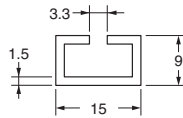
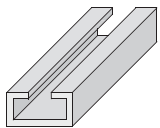

For SGE-225/245

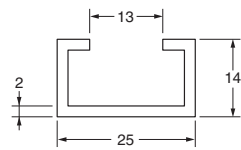
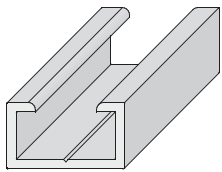

For SGE-225/245 L-shaped

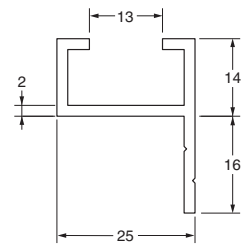
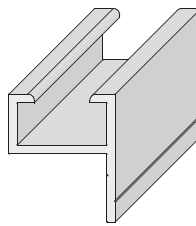

For SGE-365

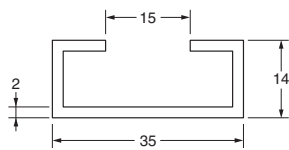
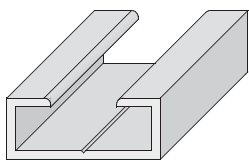

For SGE-365 L-shaped

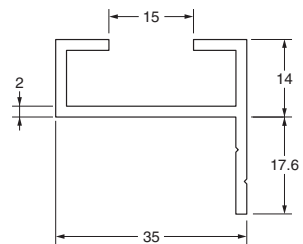
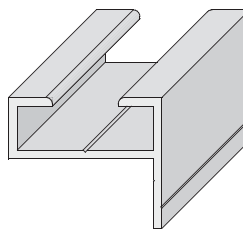

Connectors

Connector (male) Terminal code: M

Pin arrangement

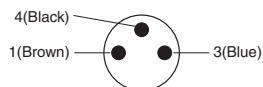
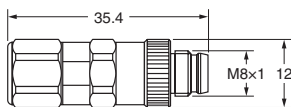

Connector (female) Terminal code: F

Pin arrangement

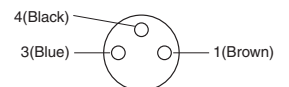
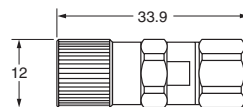

# Application Examples

Highest achievable PL/ safety category	Model	Stop category	Reset
PLd/3 equivalent	Safety Edge SGE series Safety Mat/Edge Controller SCC-1224A	0	Manual

**Note:** The above PL is only the evaluation result of the example. The PL must be evaluated in an actual application by the customer after confirming the usage conditions.

## Application Overview

- The power supply to the motor M is turned OFF when a safety edge is activated.
- The power supply to the motor M is kept OFF until the reset switch S1 is pressed after the safety edge is deactivated.

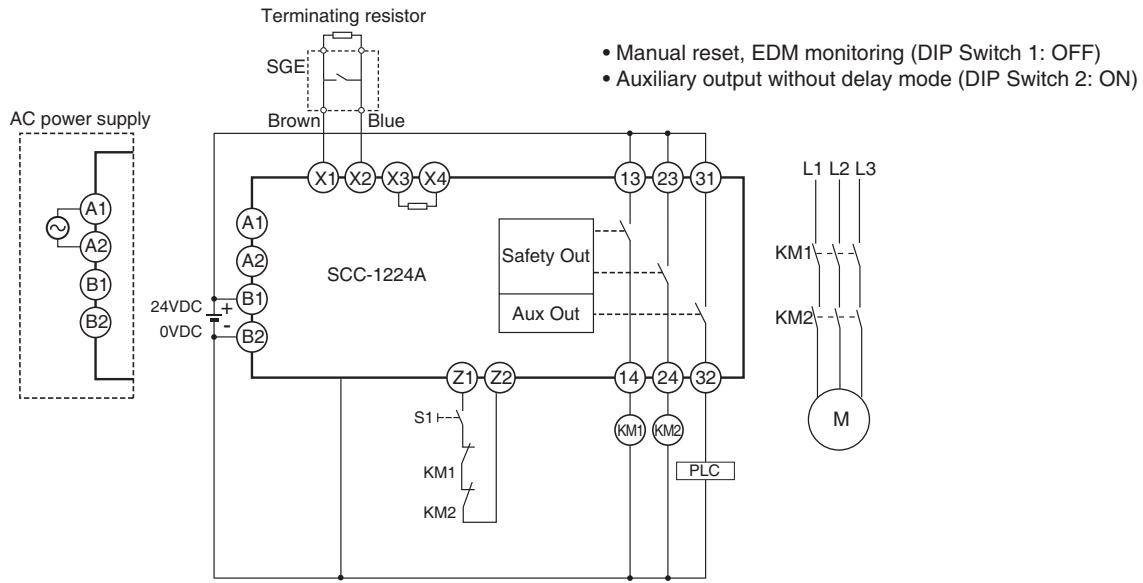

S1: Reset switch  
 KM1, KM2: Magnetic contactor  
 M: Motor

## Timing Chart

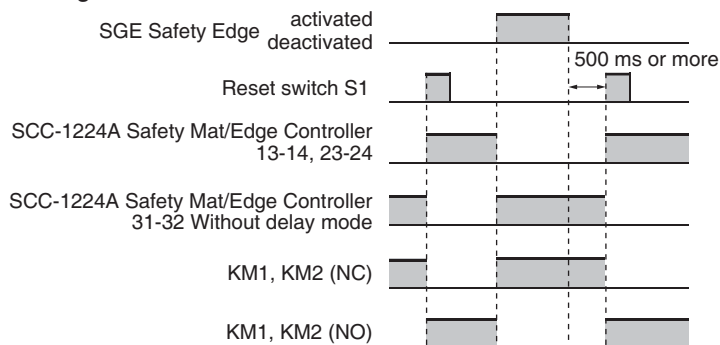

Highest achievable PL/ safety category	Model	Stop category	Reset
PLd/3 equivalent	Safety Edge SGE series Safety Mat/Edge Controller SCC-1224A Safety Relay Unit G9SA-301	0	Auto

**Note:** The above PL is only the evaluation result of the example. The PL must be evaluated in an actual application by the customer after confirming the usage conditions.

### Application Overview

- The power supply to the motor M is turned OFF when a safety edge is activated.
- The power supply to the motor M is kept OFF until the safety edge is deactivated.

- Automatic reset (DIP Switch1: ON)
- Auxiliary output without delay mode (DIP Switch 2: ON)

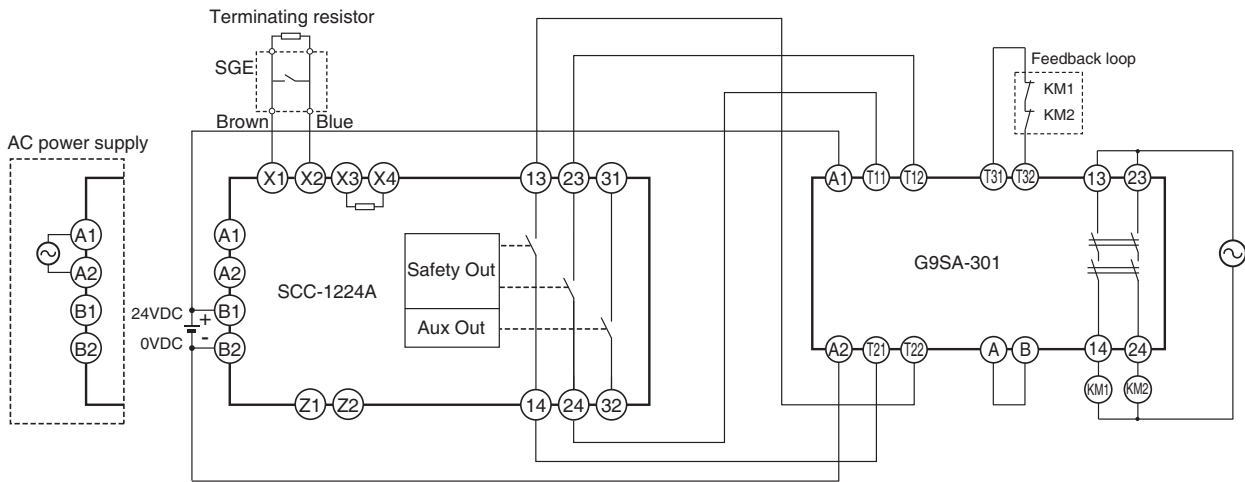

KM1, KM2: Magnetic contactor  
M: Motor

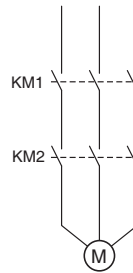

### Timing Chart

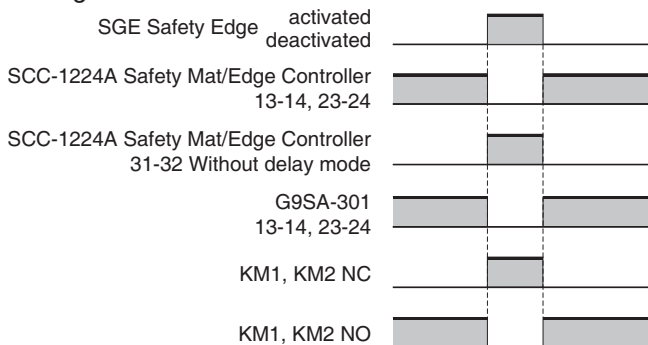

Highest achievable PL/ safety category	Model	Stop category	Reset
PLd/3 equivalent	Safety Edge SGE series Safety Mat/Edge Controller SCC-1224A	0	Manual

**Note:** The above PL is only the evaluation result of the example. The PL must be evaluated in an actual application by the customer after confirming the usage conditions.

**Application Overview**

- A slide door installed with the safety edge is operated.
- The power supply to the motor M is turned OFF when a safety edge is activated.
- The power supply to the motor M is kept OFF until the reset switch S1 is pressed after the safety edge is deactivated.

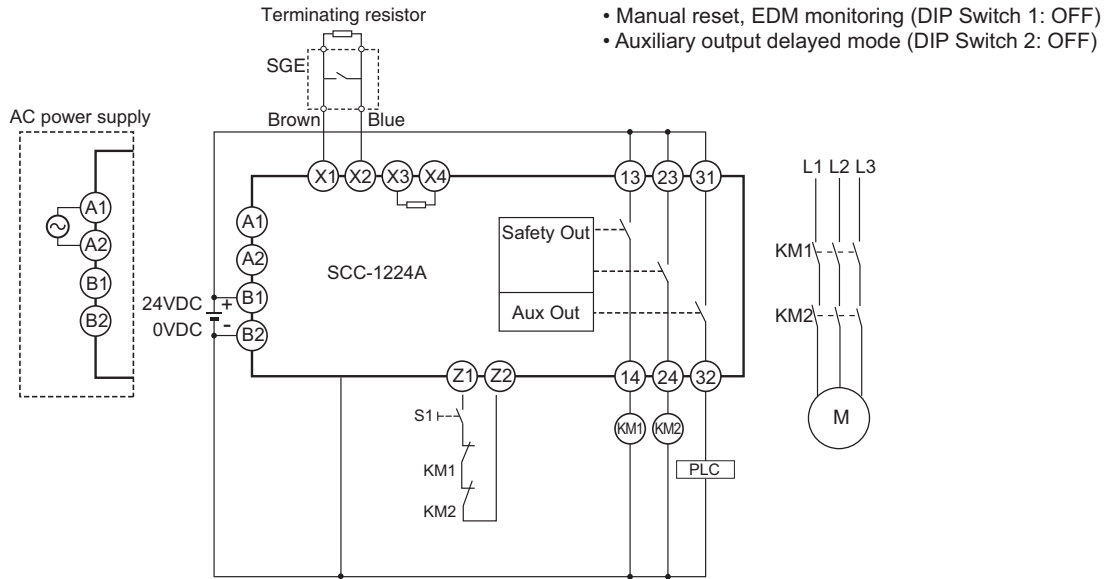

S1: Reset switch  
 KM1, KM2: Magnetic contactor  
 M: Motor

**Timing Chart**

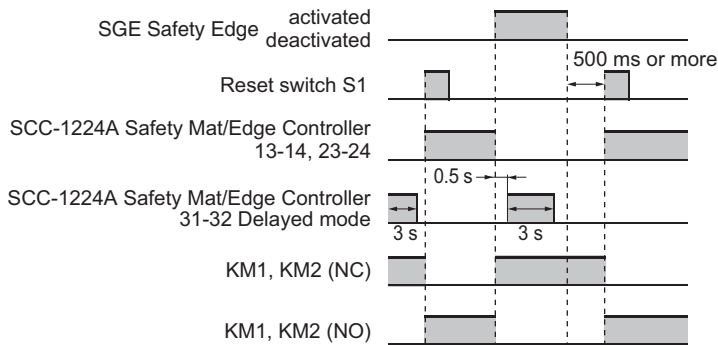

# SGE/SCC

## Safety Precautions

### Safety Category

The SGE-series Safety Edge is certified for PLd and Safety Category 3 when used with an SCC-1224A Safety Mat/Edge Controller or a G9SP-series Safety Controller.

To implement a Safety Category 3 and PLd safety circuit with an external safety relay or magnet contactor connected, a safety controller is required separately when using the Safety Edge with an SCC-1224A Safety Mat/Edge Controller which is selected automatic reset mode.

### Standards

SGE + SCC-1224A  
EN ISO 13856-2  
EN ISO 13849-1 PLd/Safety Category 3  
SGE + G9SP-□  
EN ISO13849-1 PLd/Safety Category 3

Do not use this document to operate the Unit.  
For precautions for correct use and other information, refer to your local Omron website and the *SCC-1224A Safety Mat/Edge Controller User Manual* (Cat. No. Z394).

## Related Manuals

Man. No.	Model	Manual name
Z394	SCC-1224A	SCC-1224A Safety Mat/Edge Controller User Manual

For details of the SGE-series Safety Edge, refer to your local Omron website.



# Terms and Conditions Agreement

## Read and understand this catalog.

Please read and understand this catalog before purchasing the products. Please consult your OMRON representative if you have any questions or comments.

## Warranties.

- (a) Exclusive Warranty. Omron's exclusive warranty is that the Products will be free from defects in materials and workmanship for a period of twelve months from the date of sale by Omron (or such other period expressed in writing by Omron). Omron disclaims all other warranties, express or implied.
- (b) Limitations. OMRON MAKES NO WARRANTY OR REPRESENTATION, EXPRESS OR IMPLIED, ABOUT NON-INFRINGEMENT, MERCHANTABILITY OR FITNESS FOR A PARTICULAR PURPOSE OF THE PRODUCTS. BUYER ACKNOWLEDGES THAT IT ALONE HAS DETERMINED THAT THE PRODUCTS WILL SUITABLY MEET THE REQUIREMENTS OF THEIR INTENDED USE.

Omron further disclaims all warranties and responsibility of any type for claims or expenses based on infringement by the Products or otherwise of any intellectual property right. (c) Buyer Remedy. Omron's sole obligation hereunder shall be, at Omron's election, to (i) replace (in the form originally shipped with Buyer responsible for labor charges for removal or replacement thereof) the non-complying Product, (ii) repair the non-complying Product, or (iii) repay or credit Buyer an amount equal to the purchase price of the non-complying Product; provided that in no event shall Omron be responsible for warranty, repair, indemnity or any other claims or expenses regarding the Products unless Omron's analysis confirms that the Products were properly handled, stored, installed and maintained and not subject to contamination, abuse, misuse or inappropriate modification. Return of any Products by Buyer must be approved in writing by Omron before shipment. Omron Companies shall not be liable for the suitability or unsuitability or the results from the use of Products in combination with any electrical or electronic components, circuits, system assemblies or any other materials or substances or environments. Any advice, recommendations or information given orally or in writing, are not to be construed as an amendment or addition to the above warranty.

See <http://www.omron.com/global/> or contact your Omron representative for published information.

## Limitation on Liability; Etc.

OMRON COMPANIES SHALL NOT BE LIABLE FOR SPECIAL, INDIRECT, INCIDENTAL, OR CONSEQUENTIAL DAMAGES, LOSS OF PROFITS OR PRODUCTION OR COMMERCIAL LOSS IN ANY WAY CONNECTED WITH THE PRODUCTS, WHETHER SUCH CLAIM IS BASED IN CONTRACT, WARRANTY, NEGLIGENCE OR STRICT LIABILITY.

Further, in no event shall liability of Omron Companies exceed the individual price of the Product on which liability is asserted.

## Suitability of Use.

Omron Companies shall not be responsible for conformity with any standards, codes or regulations which apply to the combination of the Product in the Buyer's application or use of the Product. At Buyer's request, Omron will provide applicable third party certification documents identifying ratings and limitations of use which apply to the Product. This information by itself is not sufficient for a complete determination of the suitability of the Product in combination with the end product, machine, system, or other application or use. Buyer shall be solely responsible for determining appropriateness of the particular Product with respect to Buyer's application, product or system. Buyer shall take application responsibility in all cases.

NEVER USE THE PRODUCT FOR AN APPLICATION INVOLVING SERIOUS RISK TO LIFE OR PROPERTY OR IN LARGE QUANTITIES WITHOUT ENSURING THAT THE SYSTEM AS A WHOLE HAS BEEN DESIGNED TO ADDRESS THE RISKS, AND THAT THE OMRON PRODUCT(S) IS PROPERLY RATED AND INSTALLED FOR THE INTENDED USE WITHIN THE OVERALL EQUIPMENT OR SYSTEM.

## Programmable Products.

Omron Companies shall not be responsible for the user's programming of a programmable Product, or any consequence thereof.

## Performance Data.

Data presented in Omron Company websites, catalogs and other materials is provided as a guide for the user in determining suitability and does not constitute a warranty. It may represent the result of Omron's test conditions, and the user must correlate it to actual application requirements. Actual performance is subject to the Omron's Warranty and Limitations of Liability.

## Change in Specifications.

Product specifications and accessories may be changed at any time based on improvements and other reasons. It is our practice to change part numbers when published ratings or features are changed, or when significant construction changes are made. However, some specifications of the Product may be changed without any notice. When in doubt, special part numbers may be assigned to fix or establish key specifications for your application. Please consult with your Omron's representative at any time to confirm actual specifications of purchased Product.

## Errors and Omissions.

Information presented by Omron Companies has been checked and is believed to be accurate; however, no responsibility is assumed for clerical, typographical or proofreading errors or omissions.

**Note: Do not use this document to operate the Unit.**

**OMRON Corporation** Industrial Automation Company  
Kyoto, JAPAN

Contact: [www.ia.omron.com](http://www.ia.omron.com)

**Regional Headquarters**

**OMRON EUROPE B.V.**  
Wegalaan 67-69, 2132 JD Hoofddorp  
The Netherlands  
Tel: (31)2356-81-300/Fax: (31)2356-81-388

**OMRON SCIENTIFIC TECHNOLOGIES INC.**  
6550 Dumbarton Circle Fremont  
CA 94555 U.S.A.  
Tel: (1) 510-608-3400/Fax: (1) 510-744-1442

**OMRON ASIA PACIFIC PTE. LTD.**  
No. 438A Alexandra Road # 05-05/08 (Lobby 2),  
Alexandra Technopark,  
Singapore 119967  
Tel: (65) 6835-3011/Fax: (65) 6835-2711

**OMRON (CHINA) CO., LTD.**  
Room 2211, Bank of China Tower,  
200 Yin Cheng Zhong Road,  
PuDong New Area, Shanghai, 200120, China  
Tel: (86) 21-5037-2222/Fax: (86) 21-5037-2200

**Authorized Distributor:**

© OMRON Corporation 2009-2017 All Rights Reserved.  
In the interest of product improvement,  
specifications are subject to change without notice.

**CSM\_8\_6\_0218**  
**Cat. No. F088-E1-06**

Printed in Japan  
0917 (1109)