

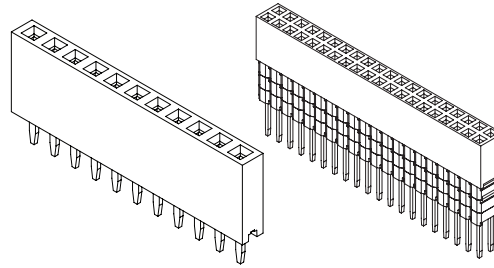

## .100" [2.54 mm] Contact Centers, Female Headers, Straight/Right Angle/SMT

### SPECIFICATIONS

- 3 Amps current rating
- UL Flammability Rating : 94V-0
- Insulator Material : PBT, Nylon
- Contact Material : Phosphor Bronze



### TERMINATION TYPE

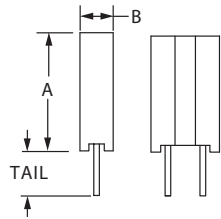

STRAIGHT

P/N CODE	ROWS	TERMINATION TYPE	A	B	TAIL
LFB	1	STRAIGHT	.335" [8.50]	.100" [2.54]	.126" [3.20]
	2	STRAIGHT	.335" [8.50]	.200" [5.08]	.126" [3.20]

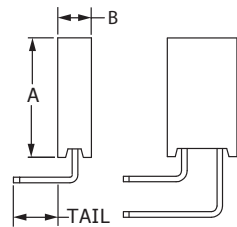

RIGHT ANGLE

P/N CODE	ROWS	TERMINATION TYPE	A	B	TAIL
LGB	1	RIGHT ANGLE	.335" [8.50]	0.100" [2.54]	.124" [3.15]
LJB	2	RIGHT ANGLE	.335" [8.50]	0.200" [5.08]	.124" [3.15]

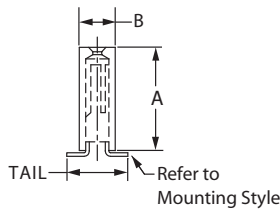

SMT

P/N CODE	ROWS	TERMINATION TYPE	ENTRY	A	B	TAIL
KFX	1	SMT	TOP ENTRY	.280" [7.10]	.098" [2.50]	.169" [4.30]
KFM	2	SMT	TOP ENTRY	.280" [7.10]	.197" [5.00]	.270" [6.85]

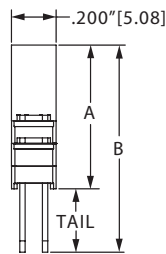

2 ROW STRAIGHT WITH ELEVATED SPACER

P/N CODE	ROWS	MODIFICATION	# OF SPACERS	A	B	TAIL
LFH	2	M44	1	.435" [11.04]	.725" [18.42]	.291" [7.38]
	2	M45	2	.535" [13.58]	.725" [18.42]	.191" [4.84]
	2	M46	3	.635" [16.12]	.725" [18.42]	.091" [2.30]
	2	M50	1	.435" [11.04]	.525" [13.34]	.091" [2.30]
	2	M51	1	.435" [11.04]	.915" [23.24]	.480" [12.20]
	2	M52	2	.535" [13.58]	.915" [23.24]	.380" [9.65]
	2	M53	3	.635" [16.12]	.914" [23.22]	.280" [7.10]
	2	M54	4	.735" [18.66]	.916" [23.26]	.181" [4.60]

### MOUNTING STYLE



No Mounting Standard (N)

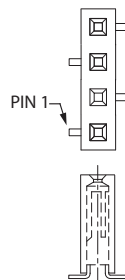

One Row SMT, Pin 1 Left (C)

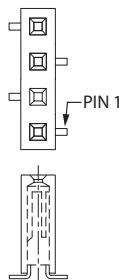

One Row SMT, Pin 1 Right (D)

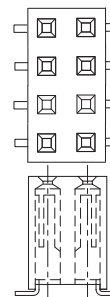

Two Row SMT, Without Guide Post (S)

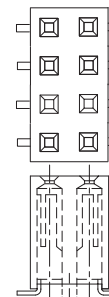

Two Row SMT, With Guide Post (P)



## .100" [2.54 mm] Contact Centers, Female Headers, Straight/Right Angle/SMT

### PART NUMBER OPTIONS

**MATERIALS (INSULATOR/CONTACT)**  
 PP = Polyester/Phosphor Bronze (Thru Hole Only)  
 NP = Nylon /Phosphor Bronze

**CONTACT FINISH - RoHS Compliant**  
 P = Gold Flash Overall  
 T = Tin Overall

**CONTACT CENTERS**  
 C = .100" [2.54 mm]

**NUMBER OF POSITIONS**  
 Contact per row, 02 Thru 40

**PP P C 36 1 LFB N - Mxx RC**

**RoHS Compliant**

**MODIFICATION (Consult Factory)**  
 Required for LFH Termination  
 See Termination Type on Opposite Page

**MOUNTING STYLE**  
 N = No Mounting  
 C = SMT, Single Row, pin 1 Left  
 D = SMT, Single Row, pin 1 Right  
 P = SMT, Dual Row with guide posts  
 S = SMT, Dual Row without guide posts

**TERMINATION TYPE**  
 LFB = Straight  
 LGB = Single Row Right Angle  
 LJB = Dual Row Right Angle  
 KFX = Single Row SMT (NP SERIES ONLY)  
 KFM = Dual Row SMT (NP SERIES ONLY)  
 LFH = Dual Row Straight with Elevated Spacer (Requires Modification see Opposite Page)

**NUMBER OF ROWS (Opposite Page)**  
 1 = Single Row  
 2 = Dual Row

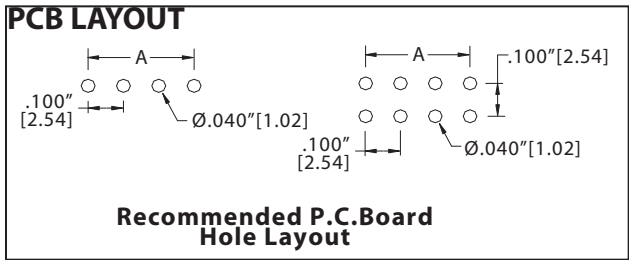

### DIMENSIONS Dimensions in [ ] are in millimeters, all others are in inches.

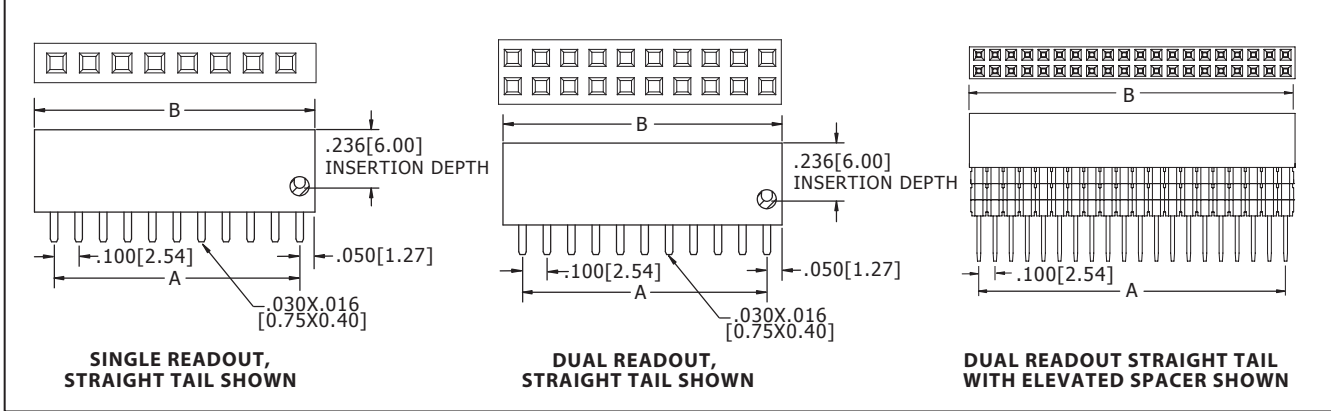

NUMBER OF POSITIONS	NUMBER OF CONTACTS		A		B	
	1 Row	2 Row	in	mm	in	mm
02	2	4	.100	2.54	.220	5.58
03	3	6	.200	5.08	.320	8.12
04	4	8	.300	7.62	.420	10.66
05	5	10	.400	10.16	.520	13.20
06	6	12	.500	12.70	.620	15.74
07	7	14	.600	15.24	.720	18.28
08	8	16	.700	17.78	.820	20.82
09	9	18	.800	20.32	.920	23.36
10	10	20	.900	22.86	1.020	25.90
11	11	22	1.000	25.40	1.120	28.44
12	12	24	1.100	27.94	1.220	30.98
13	13	26	1.200	30.48	1.320	33.52
14	14	28	1.300	33.02	1.420	36.06
15	15	30	1.400	35.56	1.520	38.60
16	16	32	1.500	38.10	1.620	41.14
17	17	34	1.600	40.64	1.720	43.68
18	18	36	1.700	43.18	1.820	46.22
19	19	38	1.800	45.72	1.920	48.76
20	20	40	1.900	48.26	2.020	51.30
21	21	42	2.000	50.80	2.120	53.84

NUMBER OF POSITIONS	NUMBER OF CONTACTS		A		B	
	1 Row	2 Row	in	mm	in	mm
22	22	44	2.100	53.34	2.220	56.38
23	23	46	2.200	55.88	2.320	58.92
24	24	48	2.300	58.42	2.420	61.46
25	25	50	2.400	60.96	2.520	64.00
26	26	52	2.500	63.50	2.620	66.54
27	27	54	2.600	66.04	2.720	69.08
28	28	56	2.700	68.58	2.820	71.62
29	29	58	2.800	71.12	2.920	74.16
30	30	60	2.900	73.66	3.020	76.70
31	31	62	3.000	76.20	3.120	79.24
32	32	64	3.100	78.74	3.220	81.78
33	33	66	3.200	81.28	3.320	84.32
34	34	68	3.300	83.82	3.420	86.86
35	35	70	3.400	86.36	3.520	89.40
36	36	72	3.500	88.90	3.620	91.94
37	37	74	3.600	91.44	3.720	94.48
38	38	76	3.700	93.98	3.820	97.02
39	39	78	3.800	96.52	3.920	99.56
40	40	80	3.900	99.06	4.020	102.10

Sullins Headers