

# Bridgelux® Gen 7 Vero® 10 Array Series

Product Data Sheet DS90



BXRC-27X1000 | 30X1000 | 35X1000 | 40X1000 | 50X1001 | 57X1001 | 65X1001

# Introduction

Vero



Vero represents a revolutionary advancement in chip on board (COB) light source technology and innovation. Vero LED light sources simplify luminaire design and manufacturing processes, improve light quality, and define a platform for future functionality integration.

Vero is available in four different light emitting surface (LES) configurations and has been engineered to reliably operate over a broad current range, enabling new degrees of flexibility in luminaire design optimization. Vero arrays deliver increased lumen density to enable improved beam control and precision lighting with 2 and 3 SDCM color control standard for clean and consistent uniform lighting.

Vero includes an on board connector port to enable solder free electrical interconnect and simple easy to use mounting features to enable plug-and-play installation.

## Features

- Efficacy of 150 lm/W typical
- Vero 10 lumen output performance ranges from 583 to 3,970 lumens
- Broad range of CCT options from 2700K to 6500K
- CRI options include minimum 70, 80, and 90
- 2 and 3 SDCM color control for 2700K-4000K CCT
- Reliable operation at up to 2X nominal drive current
- Radial die pattern and improved lumen density
- Thermally isolated solder pads
- Onboard connector port
- Top side part number markings

## Benefits

- Broad application coverage for interior and exterior lighting
- Flexibility for application driven lighting design requirements
- High quality true color reproduction
- Uniform consistent white light
- Flexibility in design optimization
- Improved optical control
- Enhanced ease of use and manufacturability
- Solderless connectivity enables plug & play installation and field upgradability
- Improved inventory management and quality control

# Contents

Product Feature Map	2
Product Nomenclature	2
Product Selection Guide	3
Performance at Commonly Used Drive Currents	7
Electrical Characteristics	13
Absolute Maximum Ratings	14
Performance Curves	15
Typical Radiation Pattern	20
Typical Color Spectrum	21
Mechanical Dimensions	22
Color Binning Information	23
Packaging and Labeling	24
Design Resources	26
Precautions	26
Disclaimers	26
About Bridgelux	27

---

# Product Feature Map

Vero 10 is the smallest form factor in the Vero family of next generation solid state light sources. In addition to delivering the performance and light quality required for many lighting applications, Vero incorporates several

features to simplify the design integration and manufacturing process, accelerate time to market and reduce system costs. Please consult the Bridgelux Vero Array Series Product Brief for more information on the Vero family of products.

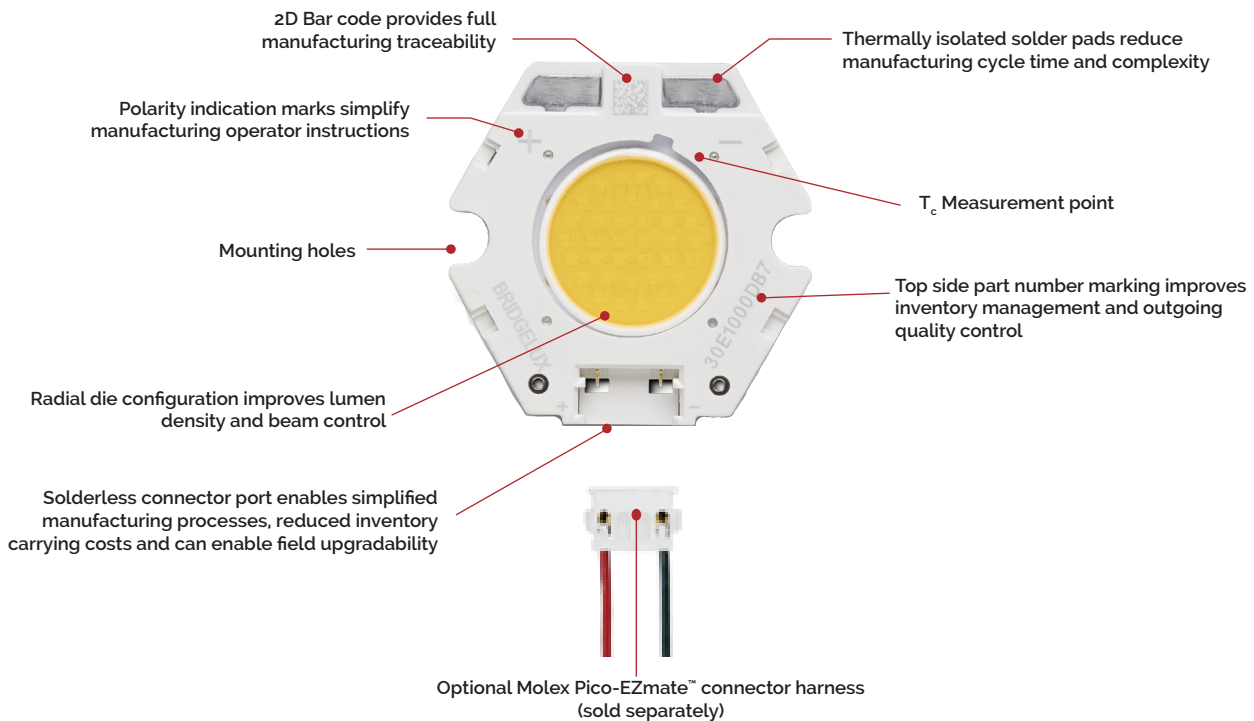

## Product Nomenclature

The part number designation for Bridgelux Vero LED arrays is explained as follows:

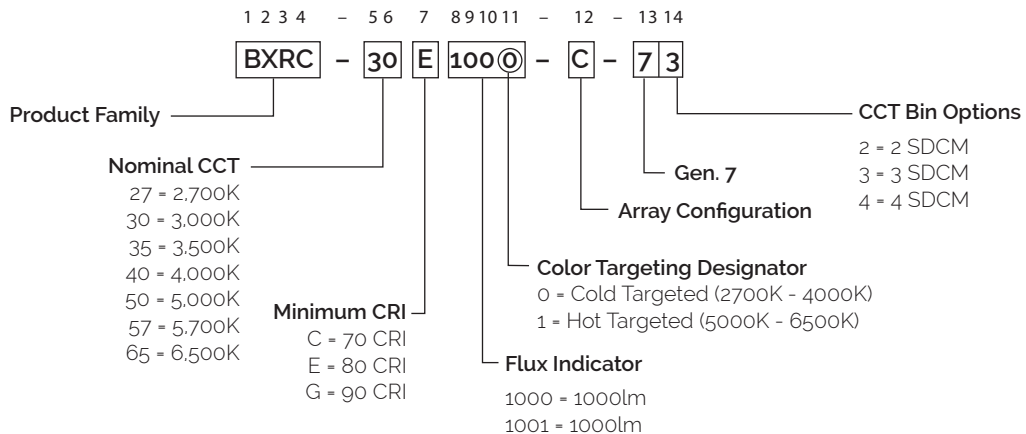

# Product Selection Guide

The following product configurations are available:

**Table 1:** Selection Guide, Pulsed Measurement Data ( $T_j = T_c = 25^\circ\text{C}$ )

Part Number	Nominal CCT <sup>1</sup> (K)	CRI <sup>2</sup>	Nominal Drive Current <sup>3</sup> (mA)	Typical Pulsed Flux <sup>4,5,6</sup> $T_c = 25^\circ\text{C}$ (lm)	Minimum Pulsed Flux <sup>6,7</sup> $T_c = 25^\circ\text{C}$ (lm)	Typical $V_f$ (V)	Typical Power (W)	Typical Efficacy (lm/W)
BXRC-27E1000-B-7X	2700	80	270	1348	1190	35.0	9.5	143
BXRC-27E1000-C-7X	2700	80	360	1797	1581	35.0	12.6	143
BXRC-27E1000-D-7X	2700	80	350	1310	1219	26.0	9.1	144
BXRC-27G1000-B-7X	2700	90	270	1124	992	35.0	9.5	119
BXRC-27G1000-C-7X	2700	90	360	1498	1318	35.0	12.6	119
BXRC-27G1000-D-7X	2700	90	350	1092	1016	26.0	9.1	120
BXRC-30E1000-B-7X	3000	80	270	1418	1240	35.0	9.5	150
BXRC-30E1000-C-7X	3000	80	360	1890	1647	35.0	12.6	150
BXRC-30E1000-D-7X	3000	80	350	1365	1270	26.0	9.1	150
BXRC-30G1000-B-7X	3000	90	270	1166	1029	35.0	9.5	123
BXRC-30G1000-C-7X	3000	90	360	1554	1367	35.0	12.6	123
BXRC-30G1000-D-7X	3000	90	350	1133	1054	26.0	9.1	125
BXRC-35E1000-B-7X	3500	80	270	1447	1277	35.0	9.5	153
BXRC-35E1000-C-7X	3500	80	360	1928	1697	35.0	12.6	153
BXRC-35E1000-D-7X	3500	80	350	1406	1308	26.0	9.1	155
BXRC-35G1000-B-7X	3500	90	270	1208	1066	35.0	9.5	128
BXRC-35G1000-C-7X	3500	90	360	1610	1417	35.0	12.6	128
BXRC-35G1000-D-7X	3500	90	350	1174	1092	26.0	9.1	129
BXRC-40E1000-B-7X	4000	80	270	1461	1290	35.0	9.5	155
BXRC-40E1000-C-7X	4000	80	360	1947	1713	35.0	12.6	155
BXRC-40E1000-D-7X	4000	80	350	1420	1321	26.0	9.1	156
BXRC-40G1000-B-7X	4000	90	270	1250	1104	35.0	9.5	132
BXRC-40G1000-C-7X	4000	90	360	1666	1466	35.0	12.6	132
BXRC-40G1000-D-7X	4000	90	350	1215	1130	26.0	9.1	134
BXRC-50C1001-B-74	5000	70	270	1601	1414	35.0	9.5	169
BXRC-50C1001-C-74	5000	70	360	2134	1878	35.0	12.6	169
BXRC-50C1001-D-74	5000	70	350	1556	1448	26.0	9.1	171
BXRC-50E1001-B-74	5000	80	270	1505	1329	35.0	9.5	159
BXRC-50E1001-C-74	5000	80	360	2006	1765	35.0	12.6	159
BXRC-50E1001-D-74	5000	80	350	1463	1361	26.0	9.1	161

Notes for Tables 1:

1. Nominal CCT as defined by ANSI C78.377-2011. Products with CCTs 5000K-6500K are hot targeted to 85°C.
2. CRI values are minimums. Minimum R<sub>g</sub> value for 80 CRI products is 0, the minimum R<sub>g</sub> values for 90 CRI products is 50.
3. Drive current is referred to as nominal drive current.
4. Products tested under pulsed condition (10ms pulse width) at nominal test current where  $T_j$  (junction temperature) =  $T_c$  (case temperature) = 25°C.
5. Typical performance values are provided as a reference only and are not a guarantee of performance.
6. Bridgelux maintains a ±7% tolerance on flux measurements.
7. Minimum flux values at the nominal test current are guaranteed by 100% test.

# Product Selection Guide

The following product configurations are available:

**Table 1:** Selection Guide, Pulsed Measurement Data ( $T_j = T_c = 25^\circ\text{C}$ ) (continued)

Part Number	Nominal CCT <sup>1</sup> (K)	CRI <sup>2</sup>	Nominal Drive Current <sup>3</sup> (mA)	Typical Pulsed Flux <sup>4,5,6</sup> $T_c = 25^\circ\text{C}$ (lm)	Minimum Pulsed Flux <sup>6,7</sup> $T_c = 25^\circ\text{C}$ (lm)	Typical $V_f$ (V)	Typical Power (W)	Typical Efficacy (lm/W)
BXRC-50G1001-B-74	5000	90	270	1281	1131	32.4	9.5	135
BXRC-50G1001-C-74	5000	90	360	1707	1502	32.4	12.6	135
BXRC-50G1001-D-74	5000	90	350	1245	1158	24.1	9.1	137
BXRC-57C1001-B-74	5700	70	270	1545	1364	32.4	9.5	163
BXRC-57C1001-C-74	5700	70	360	2059	1812	32.4	12.6	163
BXRC-57C1001-D-74	5700	70	350	1502	1397	24.1	9.1	165
BXRC-57E1001-B-74	5700	80	270	1531	1352	32.4	9.5	162
BXRC-57E1001-C-74	5700	80	360	2040	1796	32.4	12.6	162
BXRC-57E1001-D-74	5700	80	350	1488	1384	24.1	9.1	164
BXRC-65C1001-B-74	6500	70	270	1573	1389	32.4	9.5	166
BXRC-65C1001-C-74	6500	70	360	2097	1845	32.4	12.6	166
BXRC-65C1001-D-74	6500	70	350	1529	1422	24.1	9.1	168
BXRC-65E1001-B-74	6500	80	270	1559	1376	32.4	9.5	165
BXRC-65E1001-C-74	6500	80	360	2078	1829	32.4	12.6	165
BXRC-65E1001-D-74	6500	80	350	1515	1410	24.1	9.1	167

Notes for Tables 1:

1. Nominal CCT as defined by ANSI C78.377-2011. Products with a CCT of 5000K-6500K are hot targeted to  $85^\circ\text{C}$ .
2. CRI values are minimums. Minimum Rg value for 80 CRI products is 0, the minimum Rg values for 90 CRI products is 50.
3. Drive current is referred to as nominal drive current.
4. Products tested under pulsed condition (10ms pulse width) at nominal test current where  $T_j$  (junction temperature) =  $T_c$  (case temperature) =  $25^\circ\text{C}$ .
5. Typical performance values are provided as a reference only and are not a guarantee of performance.
6. Bridgelux maintains a  $\pm 7\%$  tolerance on flux measurements.
7. Minimum flux values at the nominal test current are guaranteed by 100% test.

# Product Selection Guide

**Table 2:** Selection Guide, Stabilized DC Performance ( $T_c = 85^\circ\text{C}$ )<sup>4,5</sup>

Part Number	Nominal CCT <sup>1</sup> (K)	CRI <sup>2</sup>	Nominal Drive Current <sup>3</sup> (mA)	Typical DC Flux $T_c = 85^\circ\text{C}$ (lm)	Minimum DC Flux <sup>6</sup> $T_c = 85^\circ\text{C}$ (lm)	Typical $V_f$ (V)	Typical Power (W)	Typical Efficacy (lm/W)
BXRC-27E1000-B-7X	2700	80	270	1214	1071	34.0	9.2	132
BXRC-27E1000-C-7X	2700	80	360	1617	1423	34.0	12.3	132
BXRC-27E1000-D-7X	2700	80	350	1179	1097	25.3	8.9	133
BXRC-27G1000-B-7X	2700	90	270	1011	893	34.0	9.2	110
BXRC-27G1000-C-7X	2700	90	360	1348	1186	34.0	12.3	110
BXRC-27G1000-D-7X	2700	90	350	983	914	25.3	8.9	111
BXRC-30E1000-B-7X	3000	80	270	1276	1116	34.0	9.2	139
BXRC-30E1000-C-7X	3000	80	360	1701	1483	34.0	12.3	139
BXRC-30E1000-D-7X	3000	80	350	1229	1143	25.3	8.9	139
BXRC-30G1000-B-7X	3000	90	270	1049	926	34.0	9.2	114
BXRC-30G1000-C-7X	3000	90	360	1398	1231	34.0	12.3	114
BXRC-30G1000-D-7X	3000	90	350	1020	949	25.3	8.9	115
BXRC-35E1000-B-7X	3500	80	270	1302	1149	34.0	9.2	142
BXRC-35E1000-C-7X	3500	80	360	1735	1527	34.0	12.3	142
BXRC-35E1000-D-7X	3500	80	350	1265	1177	25.3	8.9	143
BXRC-35G1000-B-7X	3500	90	270	1087	960	34.0	9.2	118
BXRC-35G1000-C-7X	3500	90	360	1449	1275	34.0	12.3	118
BXRC-35G1000-D-7X	3500	90	350	1057	983	25.3	8.9	119
BXRC-40E1000-B-7X	4000	80	270	1315	1161	34.0	9.2	143
BXRC-40E1000-C-7X	4000	80	360	1752	1542	34.0	12.3	143
BXRC-40E1000-D-7X	4000	80	350	1278	1189	25.3	8.9	144
BXRC-40G1000-B-7X	4000	90	270	1125	993	34.0	9.2	122
BXRC-40G1000-C-7X	4000	90	360	1499	1320	34.0	12.3	122
BXRC-40G1000-D-7X	4000	90	350	1093	1017	25.3	8.9	124
BXRC-50C1001-B-74	5000	70	270	1441	1272	34.0	9.2	157
BXRC-50C1001-C-74	5000	70	360	1921	1690	34.0	12.3	157
BXRC-50C1001-D-74	5000	70	350	1400	1303	25.3	8.9	158
BXRC-50E1001-B-74	5000	80	270	1355	1196	34.0	9.2	147
BXRC-50E1001-C-74	5000	80	360	1805	1589	34.0	12.3	147
BXRC-50E1001-D-74	5000	80	350	1316	1225	25.3	8.9	149

Notes for Tables 2:

- Nominal CCT as defined by ANSI C78.377-2011. Products with a CCT of 5000K-6500K are hot targeted to 85°C.
- CRI values are minimums. Minimum Rg value for 80 CRI products is 0, the minimum Rg values for 90 CRI products is 50.
- Drive current is referred to as nominal drive current.
- Typical stabilized DC performance values are provided as reference only and are not a guarantee of performance.
- Typical performance is estimated based on operation under DC (direct current) with LED array mounted onto a heat sink with thermal interface material and the case temperature maintained at 85°C. Based on Bridgelux test setup, values may vary depending on the thermal design of the luminaire and/or the exposed environment to which the product is subjected.
- Minimum flux values at elevated temperatures are provided for reference only and are not guaranteed by 100% production testing. Based on Bridgelux test setup, values may vary depending on the thermal design of the luminaire and/or the exposed environment to which the product is subjected.

# Product Selection Guide

**Table 2:** Selection Guide, Stabilized DC Performance ( $T_c = 85^\circ\text{C}$ )<sup>4,5</sup> (continued)

Part Number	Nominal CCT <sup>1</sup> (K)	CRI <sup>2</sup>	Nominal Drive Current <sup>3</sup> (mA)	Typical DC Flux $T_c = 85^\circ\text{C}$ (lm)	Minimum DC Flux <sup>6</sup> $T_c = 85^\circ\text{C}$ (lm)	Typical $V_f$ (V)	Typical Power (W)	Typical Efficacy (lm/W)
BXRC-50G1001-B-74	5000	90	270	1153	1018	36.7	9.2	125
BXRC-50G1001-C-74	5000	90	360	1537	1352	36.7	12.3	125
BXRC-50G1001-D-74	5000	90	350	1120	1042	27.0	8.9	127
BXRC-57C1001-B-74	5700	70	270	1390	1228	36.7	9.2	151
BXRC-57C1001-C-74	5700	70	360	1853	1631	36.7	12.3	151
BXRC-57C1001-D-74	5700	70	350	1351	1257	27.0	8.9	153
BXRC-57E1001-B-74	5700	80	270	1378	1216	36.7	9.2	150
BXRC-57E1001-C-74	5700	80	360	1836	1616	36.7	12.3	150
BXRC-57E1001-D-74	5700	80	350	1339	1246	27.0	8.9	151
BXRC-65C1001-B-74	6500	70	270	1416	1250	36.7	9.2	154
BXRC-65C1001-C-74	6500	70	360	1887	1661	36.7	12.3	154
BXRC-65C1001-D-74	6500	70	350	1376	1280	27.0	8.9	155
BXRC-65E1001-B-74	6500	80	270	1403	1239	36.7	9.2	153
BXRC-65E1001-C-74	6500	80	360	1870	1646	36.7	12.3	153
BXRC-65E1001-D-74	6500	80	350	1364	1269	27.0	8.9	154

Notes for Tables 2:

1. Nominal CCT as defined by ANSI C78.377-2011. Products with a CCT of 5000K-6500K are hot targeted to 85°C.
2. CRI Values are minimums. Minimum Rg value for 80 CRI products is 0, the minimum Rg values for 90 CRI products is 50.
3. Drive current is referred to as nominal drive current.
4. Typical stabilized DC performance values are provided as reference only and are not a guarantee of performance.
5. Typical performance is estimated based on operation under DC (direct current) with LED array mounted onto a heat sink with thermal interface material and the case temperature maintained at 85°C. Based on Bridgelux test setup, values may vary depending on the thermal design of the luminaire and/or the exposed environment to which the product is subjected.
6. Minimum flux values at elevated temperatures are provided for reference only and are not guaranteed by 100% production testing. Based on Bridgelux test setup, values may vary depending on the thermal design of the luminaire and/or the exposed environment to which the product is subjected.



# Performance at Commonly Used Drive Currents

Vero LED arrays are tested to the specifications shown using the nominal drive currents in Table 1. Vero may also be driven at other drive currents dependent on specific application design requirements. The performance at any drive current can be derived from the current vs. voltage characteristics shown in Figures 1, 2 & 3 and the flux vs. current characteristics shown in Figures 4, 5 & 6. The performance at commonly used drive currents is summarized in Table 3.

**Table 3:** Product Performance at Commonly Used Drive Currents

Part Number	CRI	Drive Current <sup>1</sup> (mA)	Typical V <sub>f</sub> T <sub>c</sub> = 25°C (V)	Typical Power T <sub>c</sub> = 25°C (W)	Typical Flux <sup>2</sup> T <sub>c</sub> = 25°C (lm)	Typical DC Flux <sup>3</sup> T <sub>c</sub> = 85°C (lm)	Typical Efficacy T <sub>c</sub> = 25°C (lm/W)
BXRC-27E1000-B-7X	80	135	33.3	4.5	719	646	160
		180	33.8	6.1	942	845	155
		<b>270</b>	<b>35.0</b>	<b>9.5</b>	<b>1348</b>	<b>1214</b>	<b>143</b>
		405	36.4	14.8	1978	1760	134
		540	37.8	20.4	2534	2243	124
BXRC-27E1000-C-7X	80	180	33.3	6.0	955	853	160
		240	33.8	8.1	1252	1112	154
		<b>360</b>	<b>35.0</b>	<b>12.6</b>	<b>1797</b>	<b>1617</b>	<b>143</b>
		540	36.4	19.7	2617	2273	133
		720	37.7	27.1	3343	2861	123
BXRC-27E1000-D-7X	80	175	24.9	4.4	700	636	160
		233	25.4	5.9	918	825	155
		<b>350</b>	<b>26.0</b>	<b>9.1</b>	<b>1310</b>	<b>1179</b>	<b>144</b>
		525	27.4	14.4	1929	1664	134
		700	28.4	19.9	2471	2081	124
BXRC-27G1000-B-7X	90	135	33.3	4.5	599	538	133
		180	33.8	6.1	785	704	129
		<b>270</b>	<b>35.0</b>	<b>9.5</b>	<b>1124</b>	<b>1011</b>	<b>119</b>
		405	36.4	14.8	1648	1466	112
		540	37.8	20.4	2112	1869	104
BXRC-27G1000-C-7X	90	180	33.3	6.0	796	710	133
		240	33.8	8.1	1043	927	128
		<b>360</b>	<b>35.0</b>	<b>12.6</b>	<b>1498</b>	<b>1348</b>	<b>119</b>
		540	36.4	19.7	2181	1894	111
		720	37.7	27.1	2786	2385	103
BXRC-27G1000-D-7X	90	175	24.9	4.4	583	530	134
		233	25.4	5.9	765	688	129
		<b>350</b>	<b>26.0</b>	<b>9.1</b>	<b>1092</b>	<b>983</b>	<b>120</b>
		525	27.4	14.4	1607	1386	112
		700	28.4	19.9	2059	1734	104

Notes for Table 3:

1. Alternate drive currents in Table 3 are provided for reference only and are not a guarantee of performance.
2. Bridgelux maintains a ± 7% tolerance on flux measurements.
3. Typical stabilized DC performance values are provided as reference only and are not a guarantee of performance.

# Performance at Commonly Used Drive Currents

**Table 3:** Product Performance at Commonly Used Drive Currents (Continued)

Part Number	CRI	Drive Current <sup>1</sup> (mA)	Typical $V_f$ $T_c = 25^\circ\text{C}$ (V)	Typical Power $T_c = 25^\circ\text{C}$ (W)	Typical Flux <sup>2</sup> $T_c = 25^\circ\text{C}$ (lm)	Typical DC Flux <sup>3</sup> $T_c = 85^\circ\text{C}$ (lm)	Typical Efficacy $T_c = 25^\circ\text{C}$ (lm/W)
BXRC-30E1000-B-7X	80	135	33.3	4.5	755	679	168
		180	33.8	6.1	990	888	163
		<b>270</b>	<b>35.0</b>	<b>9.5</b>	<b>1418</b>	<b>1276</b>	<b>150</b>
		405	36.4	14.8	2080	1850	141
		540	37.8	20.4	2664	2358	131
BXRC-30E1000-C-7X	80	180	33.3	6.0	1005	897	168
		240	33.8	8.1	1316	1169	162
		<b>360</b>	<b>35.0</b>	<b>12.6</b>	<b>1890</b>	<b>1701</b>	<b>150</b>
		540	36.4	19.7	2752	2391	140
		720	37.7	27.1	3516	3009	130
BXRC-30E1000-D-7X	80	175	24.9	4.4	729	663	167
		233	25.4	5.9	956	860	162
		<b>350</b>	<b>26.0</b>	<b>9.1</b>	<b>1365</b>	<b>1229</b>	<b>150</b>
		525	27.4	14.4	2009	1733	140
		700	28.4	19.9	2574	2168	129
BXRC-30G1000-B-7X	90	135	33.3	4.5	621	558	138
		180	33.8	6.1	815	731	134
		<b>270</b>	<b>35.0</b>	<b>9.5</b>	<b>1166</b>	<b>1049</b>	<b>123</b>
		405	36.4	14.8	1710	1521	116
		540	37.8	20.4	2191	1939	107
BXRC-30G1000-C-7X	90	180	33.3	6.0	826	737	138
		240	33.8	8.1	1082	961	133
		<b>360</b>	<b>35.0</b>	<b>12.6</b>	<b>1554</b>	<b>1398</b>	<b>123</b>
		540	36.4	19.7	2262	1965	115
		720	37.7	27.1	2890	2474	107
BXRC-30G1000-D-7X	90	175	24.9	4.4	605	550	139
		233	25.4	5.9	794	714	134
		<b>350</b>	<b>26.0</b>	<b>9.1</b>	<b>1133</b>	<b>1020</b>	<b>125</b>
		525	27.4	14.4	1668	1438	116
		700	28.4	19.9	2137	1799	107
BXRC-35E1000-B-7X	80	135	33.3	4.5	771	693	172
		180	33.8	6.1	1011	907	166
		<b>270</b>	<b>35.0</b>	<b>9.5</b>	<b>1447</b>	<b>1302</b>	<b>153</b>
		405	36.4	14.8	2122	1888	144
		540	37.8	20.4	2719	2407	133
BXRC-35E1000-C-7X	80	180	33.3	6.0	1025	915	171
		240	33.8	8.1	1343	1193	165
		<b>360</b>	<b>35.0</b>	<b>12.6</b>	<b>1928</b>	<b>1735</b>	<b>153</b>
		540	36.4	19.7	2808	2439	143
		720	37.7	27.1	3586	3070	132
BXRC-35E1000-D-7X	80	175	24.9	4.4	751	683	172
		233	25.4	5.9	985	885	166
		<b>350</b>	<b>26.0</b>	<b>9.1</b>	<b>1406</b>	<b>1265</b>	<b>155</b>
		525	27.4	14.4	2069	1785	144
		700	28.4	19.9	2651	2233	133

Notes for Table 3:

1. Alternate drive currents in Table 3 are provided for reference only and are not a guarantee of performance.
2. Bridgelux maintains a  $\pm 7\%$  tolerance on flux measurements.
3. Typical stabilized DC performance values are provided as reference only and are not a guarantee of performance.

# Performance at Commonly Used Drive Currents

**Table 3:** Product Performance at Commonly Used Drive Currents (Continued)

Part Number	CRI	Drive Current <sup>1</sup> (mA)	Typical V <sub>f</sub> T <sub>c</sub> = 25°C (V)	Typical Power T <sub>c</sub> = 25°C (W)	Typical Flux <sup>2</sup> T <sub>c</sub> = 25°C (lm)	Typical DC Flux <sup>3</sup> T <sub>c</sub> = 85°C (lm)	Typical Efficacy T <sub>c</sub> = 25°C (lm/W)
BXRC-35G1000-B-7X	90	135	33.3	4.5	644	578	143
		180	33.8	6.1	844	757	139
		<b>270</b>	<b>35.0</b>	<b>9.5</b>	<b>1208</b>	<b>1087</b>	<b>128</b>
		405	36.4	14.8	1772	1576	120
		540	37.8	20.4	2270	2009	111
BXRC-35G1000-C-7X	90	180	33.3	6.0	856	764	143
		240	33.8	8.1	1121	996	138
		<b>360</b>	<b>35.0</b>	<b>12.6</b>	<b>1610</b>	<b>1449</b>	<b>128</b>
		540	36.4	19.7	2344	2037	119
		720	37.7	27.1	2995	2563	110
BXRC-35G1000-D-7X	90	175	24.9	4.4	627	570	144
		233	25.4	5.9	822	739	139
		<b>350</b>	<b>26.0</b>	<b>9.1</b>	<b>1174</b>	<b>1057</b>	<b>129</b>
		525	27.4	14.4	1728	1490	120
		700	28.4	19.9	2214	1864	111
BXRC-40E1000-B-7X	80	135	33.3	4.5	778	700	173
		180	33.8	6.1	1021	915	168
		<b>270</b>	<b>35.0</b>	<b>9.5</b>	<b>1461</b>	<b>1315</b>	<b>155</b>
		405	36.4	14.8	2143	1906	145
		540	37.8	20.4	2745	2430	135
BXRC-40E1000-C-7X	80	180	33.3	6.0	1035	924	173
		240	33.8	8.1	1356	1205	167
		<b>360</b>	<b>35.0</b>	<b>12.6</b>	<b>1947</b>	<b>1752</b>	<b>155</b>
		540	36.4	19.7	2835	2463	144
		720	37.7	27.1	3621	3100	133
BXRC-40E1000-D-7X	80	175	24.9	4.4	758	689	174
		233	25.4	5.9	994	894	168
		<b>350</b>	<b>26.0</b>	<b>9.1</b>	<b>1420</b>	<b>1278</b>	<b>156</b>
		525	27.4	14.4	2090	1802	145
		700	28.4	19.9	2677	2254	135
BXRC-40G1000-B-7X	90	135	33.3	4.5	666	599	148
		180	33.8	6.1	873	783	143
		<b>270</b>	<b>35.0</b>	<b>9.5</b>	<b>1250</b>	<b>1125</b>	<b>132</b>
		405	36.4	14.8	1834	1631	124
		540	37.8	20.4	2349	2079	115
BXRC-40G1000-C-7X	90	180	33.3	6.0	886	790	148
		240	33.8	8.1	1160	1031	143
		<b>360</b>	<b>35.0</b>	<b>12.6</b>	<b>1666</b>	<b>1499</b>	<b>132</b>
		540	36.4	19.7	2426	2108	123
		720	37.7	27.1	3099	2653	114
BXRC-40G1000-D-7X	90	175	24.9	4.4	649	590	149
		233	25.4	5.9	851	765	144
		<b>350</b>	<b>26.0</b>	<b>9.1</b>	<b>1215</b>	<b>1093</b>	<b>134</b>
		525	27.4	14.4	1788	1542	124
		700	28.4	19.9	2291	1929	115

Notes for Table 3:

1. Alternate drive currents in Table 3 are provided for reference only and are not a guarantee of performance.
2. Bridgelux maintains a ± 7% tolerance on flux measurements.
3. Typical stabilized DC performance values are provided as reference only and are not a guarantee of performance.

# Performance at Commonly Used Drive Currents

**Table 3:** Product Performance at Commonly Used Drive Currents (Continued)

Part Number	CRI	Drive Current <sup>1</sup> (mA)	Typical $V_f$ $T_c = 25^\circ\text{C}$ (V)	Typical Power $T_c = 25^\circ\text{C}$ (W)	Typical Flux <sup>2</sup> $T_c = 25^\circ\text{C}$ (lm)	Typical DC Flux <sup>3</sup> $T_c = 85^\circ\text{C}$ (lm)	Typical Efficacy $T_c = 25^\circ\text{C}$ (lm/W)
BXRC-50C1001-B-74	70	135	33.3	4.5	853	767	190
		180	33.8	6.1	1119	1003	184
		<b>270</b>	<b>35.0</b>	<b>9.5</b>	<b>1601</b>	<b>1441</b>	<b>169</b>
		405	36.4	14.8	2349	2090	159
		540	37.8	20.4	3009	2664	148
BXRC-50C1001-C-74	70	180	33.3	6.0	1135	1012	190
		240	33.8	8.1	1486	1321	183
		<b>360</b>	<b>35.0</b>	<b>12.6</b>	<b>2134</b>	<b>1921</b>	<b>169</b>
		540	36.4	19.7	3108	2700	158
		720	37.7	27.1	3970	3398	146
BXRC-50C1001-D-74	70	175	24.9	4.4	831	755	190
		233	25.4	5.9	1090	980	184
		<b>350</b>	<b>26.0</b>	<b>9.1</b>	<b>1556</b>	<b>1400</b>	<b>171</b>
		525	27.4	14.4	2290	1975	159
		700	28.4	19.9	2934	2471	148
BXRC-50E1001-B-74	80	135	33.3	4.5	802	721	179
		180	33.8	6.1	1052	943	173
		<b>270</b>	<b>35.0</b>	<b>9.5</b>	<b>1505</b>	<b>1355</b>	<b>159</b>
		405	36.4	14.8	2208	1964	150
		540	37.8	20.4	2829	2504	139
BXRC-50E1001-C-74	80	180	33.3	6.0	1067	952	178
		240	33.8	8.1	1397	1241	172
		<b>360</b>	<b>35.0</b>	<b>12.6</b>	<b>2006</b>	<b>1805</b>	<b>159</b>
		540	36.4	19.7	2921	2538	149
		720	37.7	27.1	3731	3194	138
BXRC-50E1001-D-74	80	175	24.9	4.4	781	710	179
		233	25.4	5.9	1025	921	173
		<b>350</b>	<b>26.0</b>	<b>9.1</b>	<b>1463</b>	<b>1316</b>	<b>161</b>
		525	27.4	14.4	2153	1857	150
		700	28.4	19.9	2758	2323	139
BXRC-50G1001-B-74	90	135	33.3	4.5	683	613	152
		180	33.8	6.1	895	803	146
		<b>270</b>	<b>35.0</b>	<b>9.5</b>	<b>1281</b>	<b>1153</b>	<b>135</b>
		405	36.4	14.8	1879	1672	126
		540	37.8	20.4	2408	2131	117
BXRC-50G1001-C-74	90	180	33.3	6.0	908	810	152
		240	33.8	8.1	1189	1056	146
		<b>360</b>	<b>35.0</b>	<b>12.6</b>	<b>1707</b>	<b>1537</b>	<b>135</b>
		540	36.4	19.7	2486	2160	126
		720	37.7	27.1	3176	2718	117
BXRC-50G1001-D-74	90	175	24.9	4.4	665	604	152
		233	25.4	5.9	872	784	147
		<b>350</b>	<b>26.0</b>	<b>9.1</b>	<b>1245</b>	<b>1120</b>	<b>137</b>
		525	27.4	14.4	1832	1580	127
		700	28.4	19.9	2348	1977	118

Notes for Table 3:

1. Alternate drive currents in Table 3 are provided for reference only and are not a guarantee of performance.
2. Bridgelux maintains a  $\pm 7\%$  tolerance on flux measurements.
3. Typical stabilized DC performance values are provided as reference only and are not a guarantee of performance.

# Performance at Commonly Used Drive Currents

**Table 3:** Product Performance at Commonly Used Drive Currents (Continued)

Part Number	CRI	Drive Current <sup>1</sup> (mA)	Typical V <sub>f</sub> T <sub>c</sub> = 25°C (V)	Typical Power T <sub>c</sub> = 25°C (W)	Typical Flux <sup>2</sup> T <sub>c</sub> = 25°C (lm)	Typical DC Flux <sup>3</sup> T <sub>c</sub> = 85°C (lm)	Typical Efficacy T <sub>c</sub> = 25°C (lm/W)
BXRC-57C1001-B-74	70	135	33.3	4.5	823	740	183
		180	33.8	6.1	1079	968	177
		<b>270</b>	<b>35.0</b>	<b>9.5</b>	<b>1545</b>	<b>1390</b>	<b>163</b>
		405	36.4	14.8	2267	2016	154
		540	37.8	20.4	2904	2570	142
BXRC-57C1001-C-74	70	180	33.3	6.0	1095	977	183
		240	33.8	8.1	1434	1274	177
		<b>360</b>	<b>35.0</b>	<b>12.6</b>	<b>2059</b>	<b>1853</b>	<b>163</b>
		540	36.4	19.7	2998	2605	153
		720	37.7	27.1	3830	3279	141
BXRC-57C1001-D-74	70	175	24.9	4.4	802	729	184
		233	25.4	5.9	1052	946	178
		<b>350</b>	<b>26.0</b>	<b>9.1</b>	<b>1502</b>	<b>1351</b>	<b>165</b>
		525	27.4	14.4	2210	1906	154
		700	28.4	19.9	2832	2384	142
BXRC-57E1001-B-74	80	135	33.3	4.5	816	733	182
		180	33.8	6.1	1070	959	176
		<b>270</b>	<b>35.0</b>	<b>9.5</b>	<b>1531</b>	<b>1378</b>	<b>162</b>
		405	36.4	14.8	2246	1998	152
		540	37.8	20.4	2877	2547	141
BXRC-57E1001-C-74	80	180	33.3	6.0	1085	968	181
		240	33.8	8.1	1421	1263	175
		<b>360</b>	<b>35.0</b>	<b>12.6</b>	<b>2040</b>	<b>1836</b>	<b>162</b>
		540	36.4	19.7	2971	2581	151
		720	37.7	27.1	3795	3249	140
BXRC-57E1001-D-74	80	175	24.9	4.4	794	722	182
		233	25.4	5.9	1042	937	176
		<b>350</b>	<b>26.0</b>	<b>9.1</b>	<b>1488</b>	<b>1339</b>	<b>164</b>
		525	27.4	14.4	2190	1889	152
		700	28.4	19.9	2806	2363	141
BXRC-65C1001-B-74	70	135	33.3	4.5	838	753	187
		180	33.8	6.1	1099	986	180
		<b>270</b>	<b>35.0</b>	<b>9.5</b>	<b>1573</b>	<b>1416</b>	<b>166</b>
		405	36.4	14.8	2308	2053	156
		540	37.8	20.4	2957	2617	145
BXRC-65C1001-C-74	70	180	33.3	6.0	1115	995	186
		240	33.8	8.1	1460	1297	180
		<b>360</b>	<b>35.0</b>	<b>12.6</b>	<b>2097</b>	<b>1887</b>	<b>166</b>
		540	36.4	19.7	3053	2652	155
		720	37.7	27.1	3900	3338	144
BXRC-65C1001-D-74	70	175	24.9	4.4	816	742	187
		233	25.4	5.9	1071	963	181
		<b>350</b>	<b>26.0</b>	<b>9.1</b>	<b>1529</b>	<b>1376</b>	<b>168</b>
		525	27.4	14.4	2250	1941	157
		700	28.4	19.9	2883	2428	145

Notes for Table 3:

1. Alternate drive currents in Table 3 are provided for reference only and are not a guarantee of performance.
2. Bridgelux maintains a ± 7% tolerance on flux measurements.
3. Typical stabilized DC performance values are provided as reference only and are not a guarantee of performance.

# Performance at Commonly Used Drive Currents

**Table 3:** Product Performance at Commonly Used Drive Currents (Continued)

Part Number	CRI	Drive Current <sup>1</sup> (mA)	Typical $V_f$ $T_c = 25^\circ\text{C}$ (V)	Typical Power $T_c = 25^\circ\text{C}$ (W)	Typical Flux <sup>2</sup> $T_c = 25^\circ\text{C}$ (lm)	Typical DC Flux <sup>3</sup> $T_c = 85^\circ\text{C}$ (lm)	Typical Efficacy $T_c = 25^\circ\text{C}$ (lm/W)
BXRC-65E1001-B-74	80	135	33.3	4.5	831	747	185
		180	33.8	6.1	1089	977	179
		<b>270</b>	<b>35.0</b>	<b>9.5</b>	<b>1559</b>	<b>1403</b>	<b>165</b>
		405	36.4	14.8	2287	2035	155
		540	37.8	20.4	2930	2593	144
BXRC-65E1001-C-74	80	180	33.3	6.0	1105	986	185
		240	33.8	8.1	1447	1286	178
		<b>360</b>	<b>35.0</b>	<b>12.6</b>	<b>2078</b>	<b>1870</b>	<b>165</b>
		540	36.4	19.7	3026	2629	154
		720	37.7	27.1	3865	3309	142
BXRC-65E1001-D-74	80	175	24.9	4.4	809	736	185
		233	25.4	5.9	1061	954	179
		<b>350</b>	<b>26.0</b>	<b>9.1</b>	<b>1515</b>	<b>1364</b>	<b>167</b>
		525	27.4	14.4	2230	1923	155
		700	28.4	19.9	2857	2406	144

Notes for Table 3:

1. Alternate drive currents in Table 3 are provided for reference only and are not a guarantee of performance.
2. Bridgelux maintains a  $\pm 7\%$  tolerance on flux measurements.
3. Typical stabilized DC performance values are provided as reference only and are not a guarantee of performance.

# Electrical Characteristics

**Table 4:** Electrical Characteristics

Part Number	Drive Current (mA)	Forward Voltage Pulsed, $T_c = 25^\circ\text{C}$ (V) <sup>1, 2, 3, 8</sup>			Typical Coefficient of Forward Voltage <sup>4</sup> $\Delta V_f / \Delta T_c$ (mV/ $^\circ\text{C}$ )	Typical Thermal Resistance Junction to Case <sup>5,6</sup> $R_{j-c}$ ( $^\circ\text{C}/\text{W}$ )	Driver Selection Voltages <sup>7</sup> (V)	
		Minimum	Typical	Maximum			$V_f$ Min. Hot $T_c = 105^\circ\text{C}$ (V)	$V_f$ Max. Cold $T_c = -40^\circ\text{C}$ (V)
BXRC-xxx100x-B-7x	270	32.4	35.0	37.6	-16.1	0.49	31.1	38.7
	540	34.9	37.8	40.6	-16.1	0.57	33.6	41.6
BXRC-xxx100x-C-7x	360	32.4	35.0	37.6	-16.1	0.37	31.1	38.7
	720	34.9	37.7	40.5	-16.1	0.43	33.6	41.6
BXRC-xxx100x-D-7x	350	24.1	26.0	28.0	-11.8	0.49	23.1	28.7
	700	26.3	28.4	30.5	-11.8	0.57	25.3	31.3

Notes for Table 4:

1. Parts are tested in pulsed conditions,  $T_c = 25^\circ\text{C}$ . Pulse width is 10ms.
2. Voltage minimum and maximum are provided for reference only and are not a guarantee of performance.
3. Bridgelux maintains a tester tolerance of  $\pm 0.10\text{V}$  on forward voltage measurements.
4. Typical coefficient of forward voltage tolerance is  $\pm 0.1\text{mV}$  for nominal current.
5. Thermal resistance values are based from test data of a 3000K 80 CRI product.
6. Thermal resistance value was calculated using total electrical input power; optical power was not subtracted from input power. The thermal interface material used during testing is not included in the thermal resistance value.
7.  $V_f$  min hot and max cold values are provided as reference only and are not guaranteed by test. These values are provided to aid in driver design and selection over the operating range of the product.
8. This product has been designed and manufactured per IEC 62031:2014. This product has passed dielectric withstand voltage testing at 1120 V. The working voltage designated for the insulation is 60V d.c. The maximum allowable voltage across the array must be determined in the end product application.

# Absolute Maximum Ratings

**Table 5:** Maximum Ratings

Parameter	Maximum Rating		
LED Junction Temperature (T <sub>j</sub> )	125°C		
Storage Temperature	-40°C to +105°C		
Operating Case Temperature <sup>1</sup> (T <sub>c</sub> )	105°C		
Soldering Temperature <sup>2</sup>	350°C or lower for a maximum of 10 seconds		
	BXRC-xxx100x-B-7x	BXRC-xxx100x-C-7x	BXRC-xxx100x-D-7x
Maximum Drive Current <sup>3</sup>	540mA	720mA	700mA
Maximum Peak Pulsed Drive Current <sup>4</sup>	771mA	1029mA	1000mA
Maximum Reverse Voltage <sup>5</sup>	-60V	-60V	-45V

Notes for Table 5:

1. For IEC 62717 requirement, please consult your Bridgelux sales representative.
2. Refer to Bridgelux Application Note AN31: Assembly Considerations for Bridgelux Vero LED Arrays.
3. Arrays may be driven at higher currents however lumen maintenance may be reduced.
4. Bridgelux recommends a maximum duty cycle of 10% and pulse width of 20 ms when operating LED Arrays at maximum peak pulsed current specified. Maximum peak pulsed currents indicate values where LED Arrays can be driven without catastrophic failures.
5. Light emitting diodes are not designed to be driven in reverse voltage and will not produce light under this condition. Maximum rating provided for reference only.



# Performance Curves

Figure 1: Vero 10B Drive Current vs. Voltage ( $T_j = T_c = 25^\circ\text{C}$ )

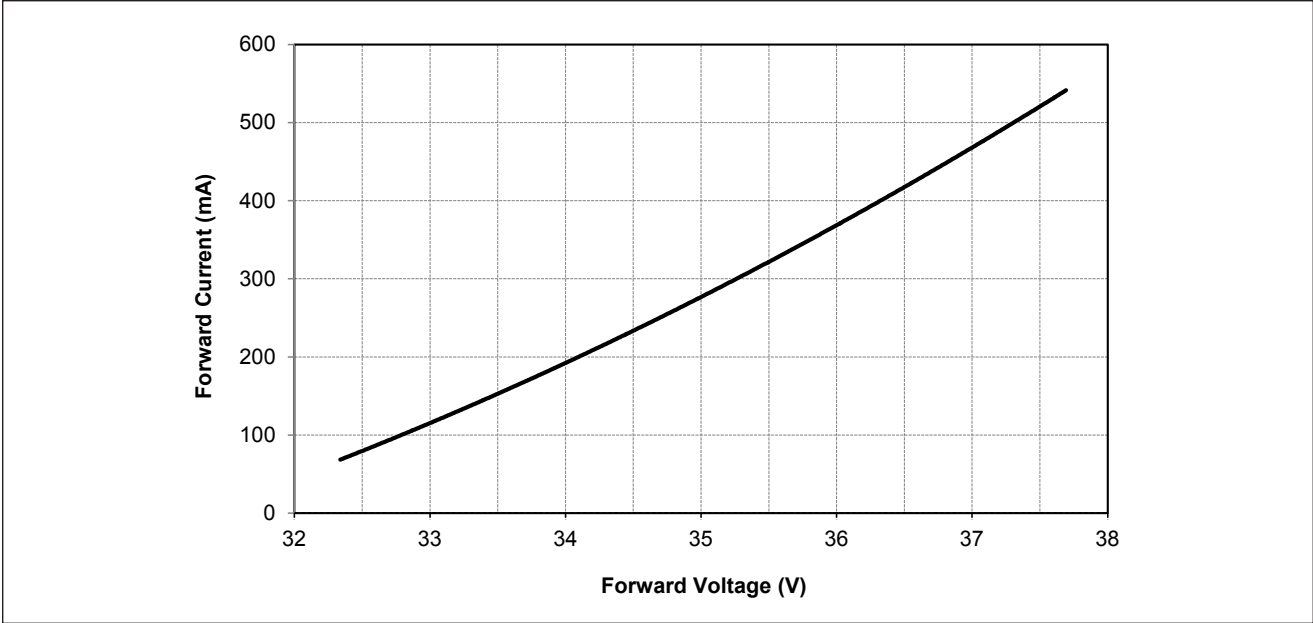
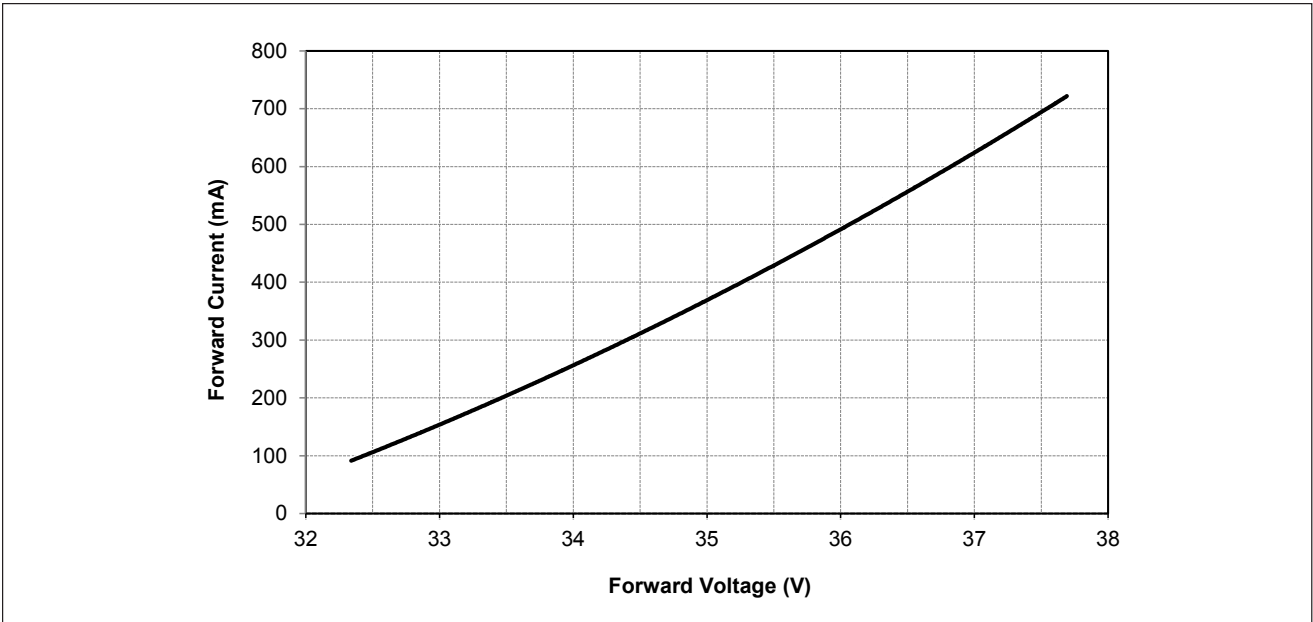

Figure 2: Vero 10C Drive Current vs. Voltage ( $T_j = T_c = 25^\circ\text{C}$ )



# Performance Curves

Figure 3: Vero 10D Drive Current vs. Voltage ( $T_j = T_c = 25^\circ\text{C}$ )

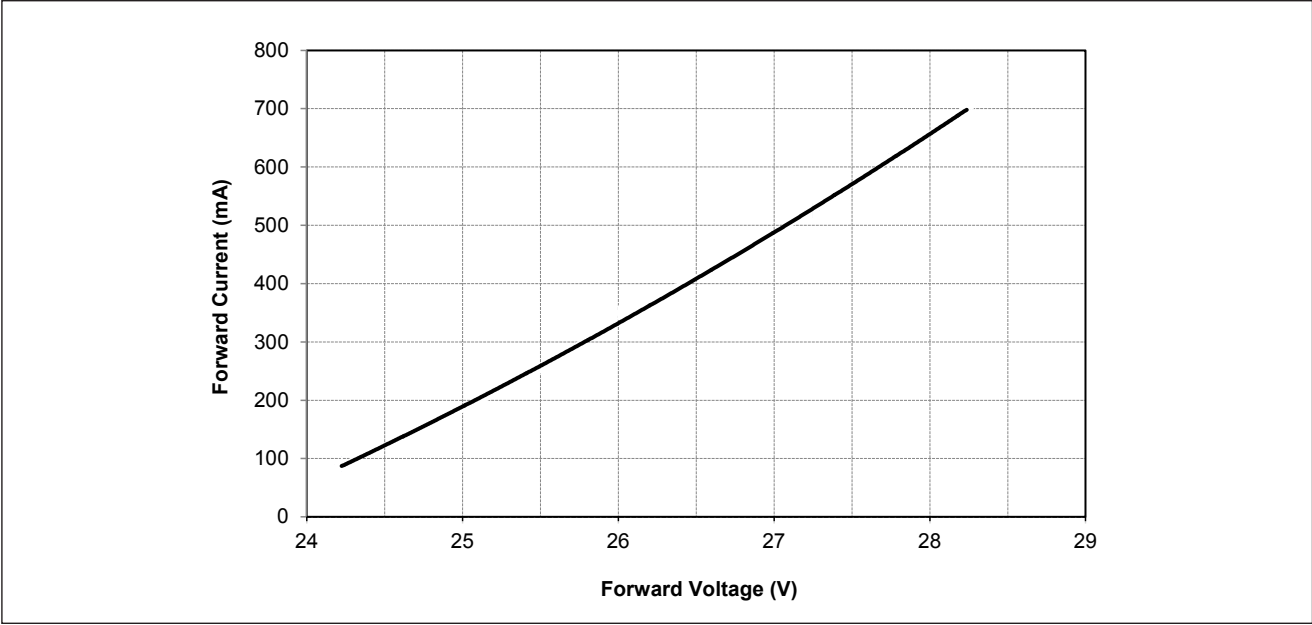
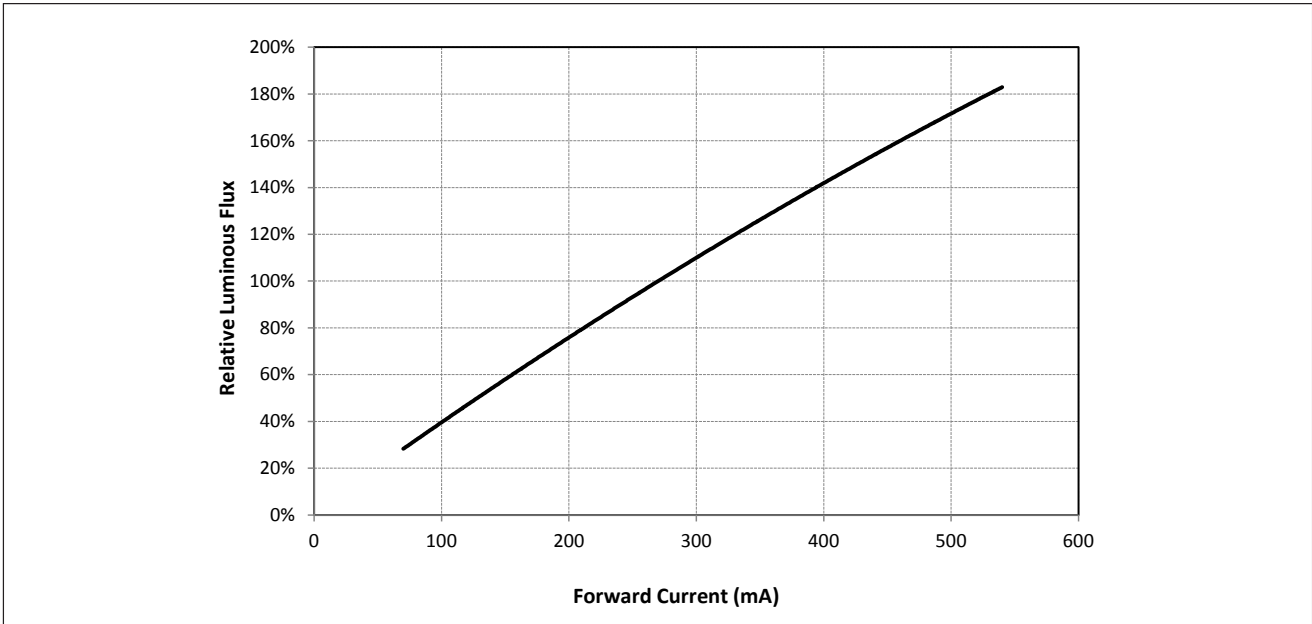

Figure 4: Vero 10B Typical Relative Flux vs. Current ( $T_j = T_c = 25^\circ\text{C}$ )



Note for Figure 4:

- 1. Bridgelux does not recommend driving high power LEDs at low currents. Doing so may produce unpredictable results. Pulse width modulation (PWM) is recommended for dimming effects.

# Performance Curves

Figure 5: Vero 10C Typical Relative Flux vs. Current ( $T_j = T_c = 25^\circ\text{C}$ )

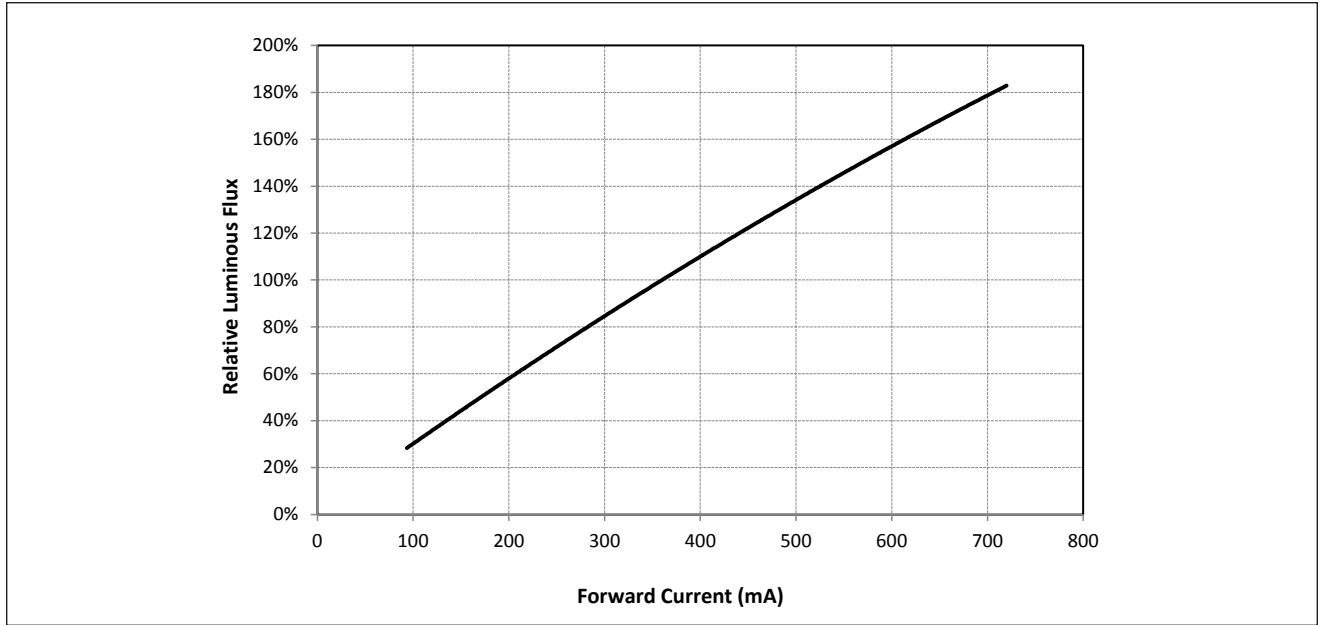
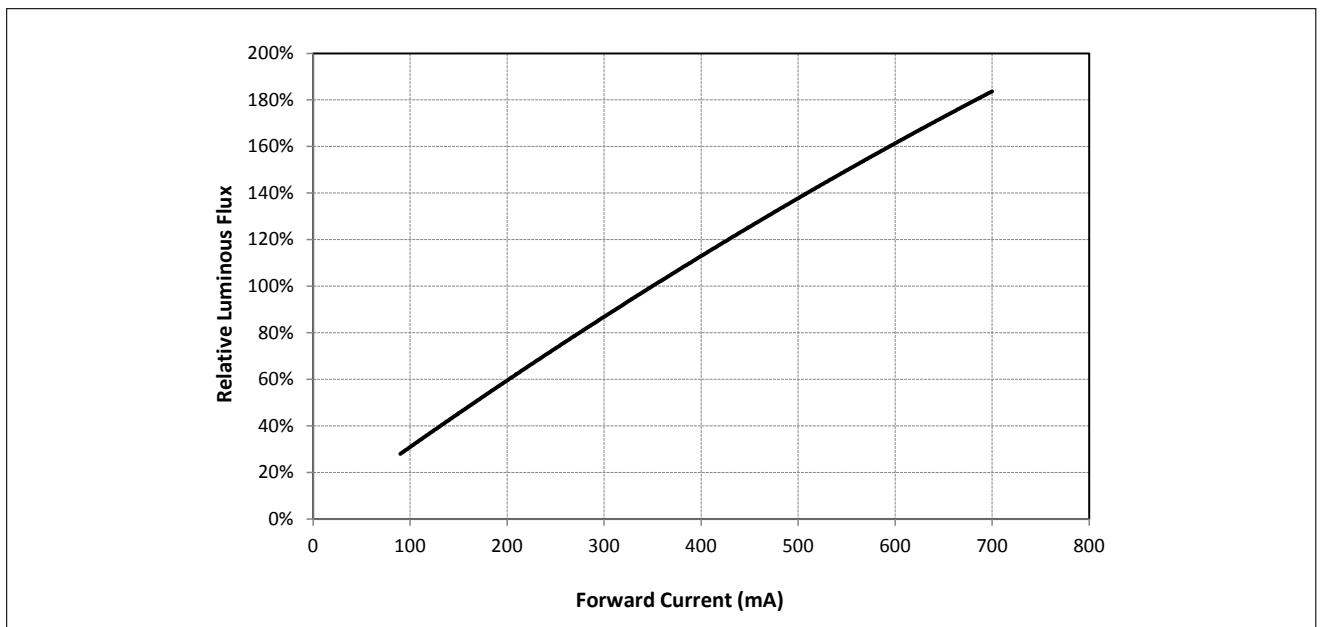

Figure 6 Vero 10D Typical Relative Flux vs. Current ( $T_j = T_c = 25^\circ\text{C}$ )



Note for Figures 5 & 6:

1. Bridgelux does not recommend driving high power LEDs at low currents. Doing so may produce unpredictable results. Pulse width modulation (PWM) is recommended for dimming effects.

# Performance Curves

**Figure 7: Typical DC Flux vs. Case Temperature**

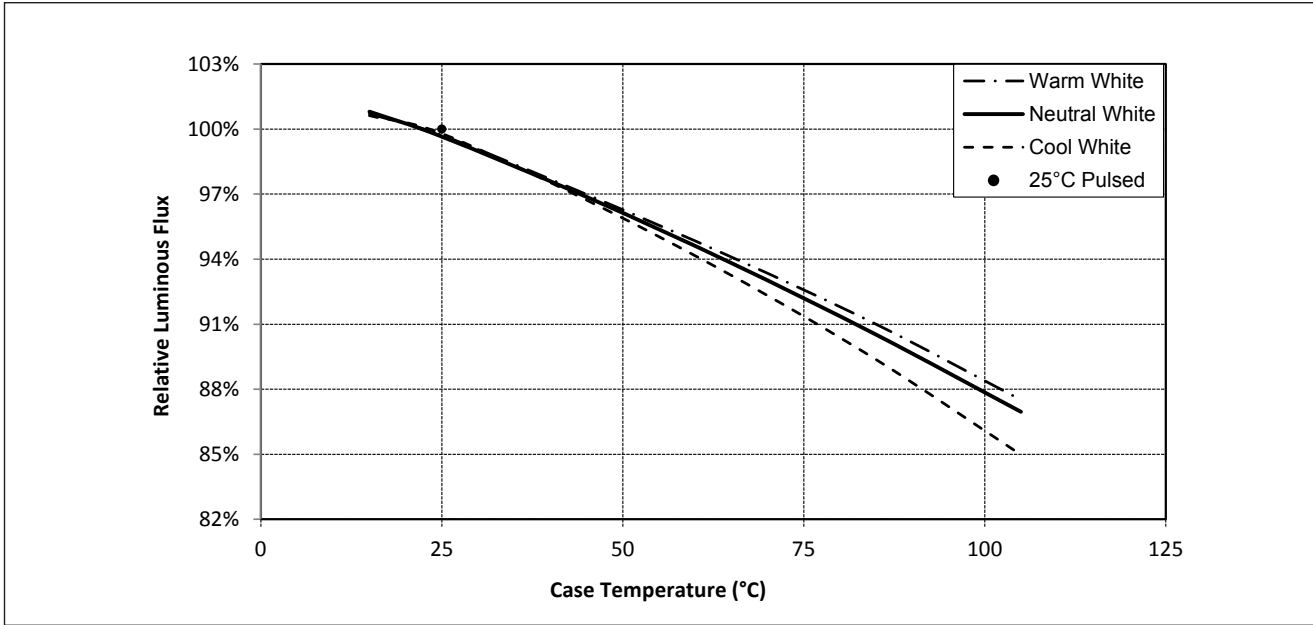

**Figure 8: Typical DC ccy Shift vs. Case Temperature**

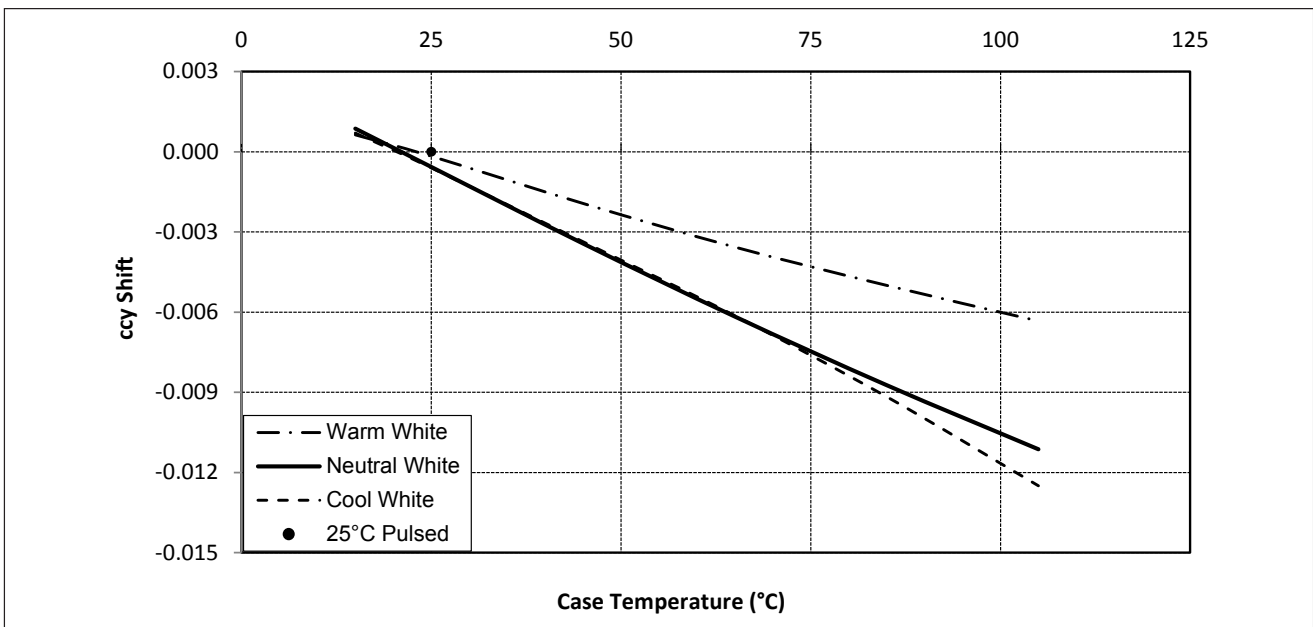

Notes for Figures 7 & 8:

1. Characteristics shown for warm white based on 3000K and 80 CRI.
2. Characteristics shown for neutral white based on 4000K and 80 CRI.
3. Characteristics shown for cool white based on 5000K and 70 CRI.
4. For other color SKUs, the shift in color will vary. Please contact your Bridgelux Sales Representative for more information.

# Performance Curves

Figure 9: Typical DC ccx Shift vs. Case Temperature

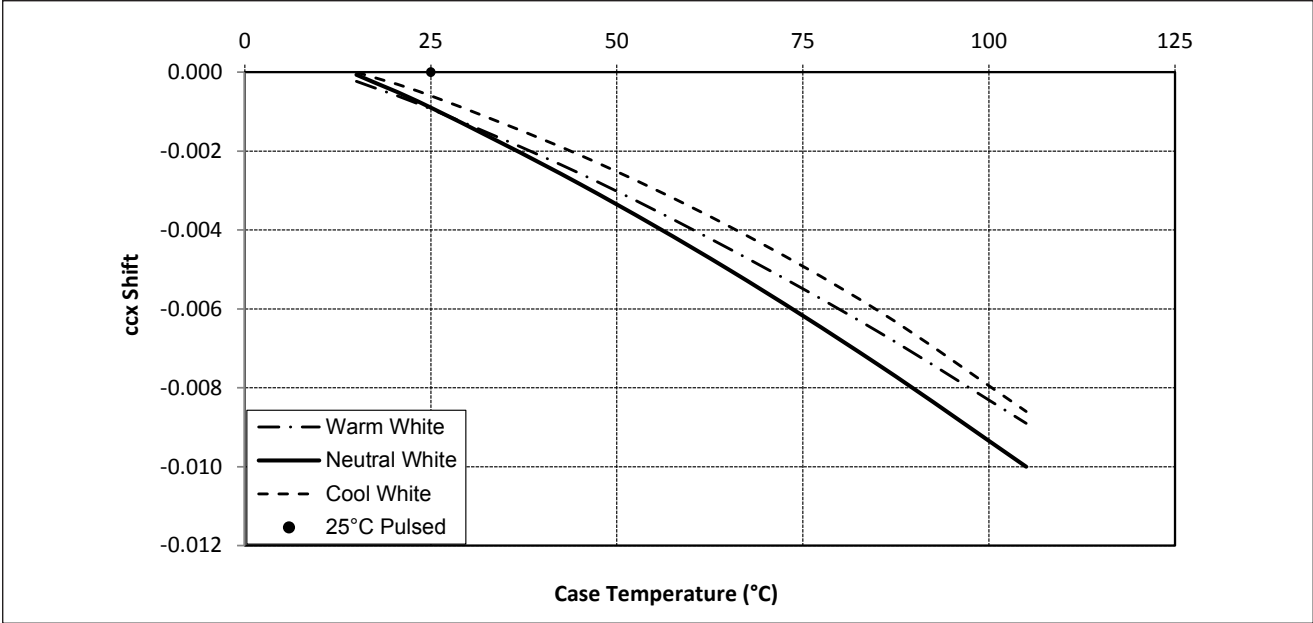

Notes for Figure 9:

- 1. Characteristics shown for warm white based on 3000K and 80 CRI.
- 2. Characteristics shown for neutral white based on 4000K and 80 CRI.
- 3. Characteristics shown for cool white based on 5000K and 70 CRI.
- 4. For other color SKUs, the shift in color will vary. Please contact your Bridgelux Sales Representative for more information.

# Typical Radiation Pattern

Figure 10: Typical Spatial Radiation Pattern

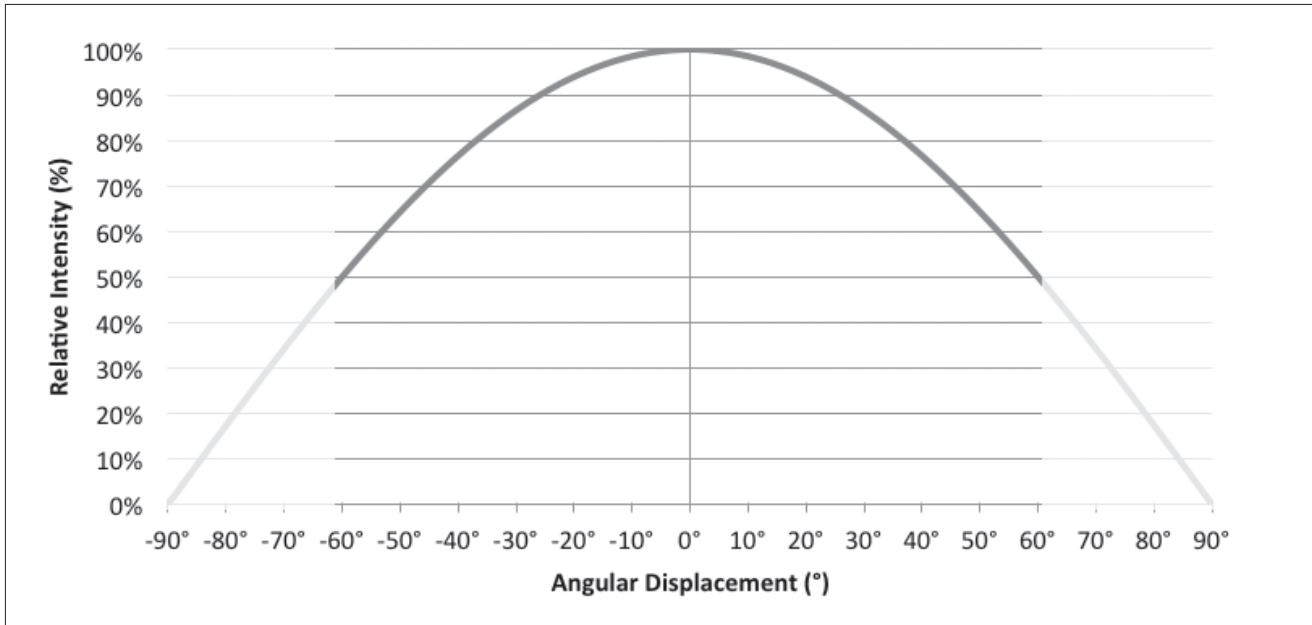

Notes for Figure 10:

1. Typical viewing angle is 120°.
2. The viewing angle is defined as the off axis angle from the centerline where intensity is ½ of the peak value.

Figure 11: Typical Polar Radiation Pattern

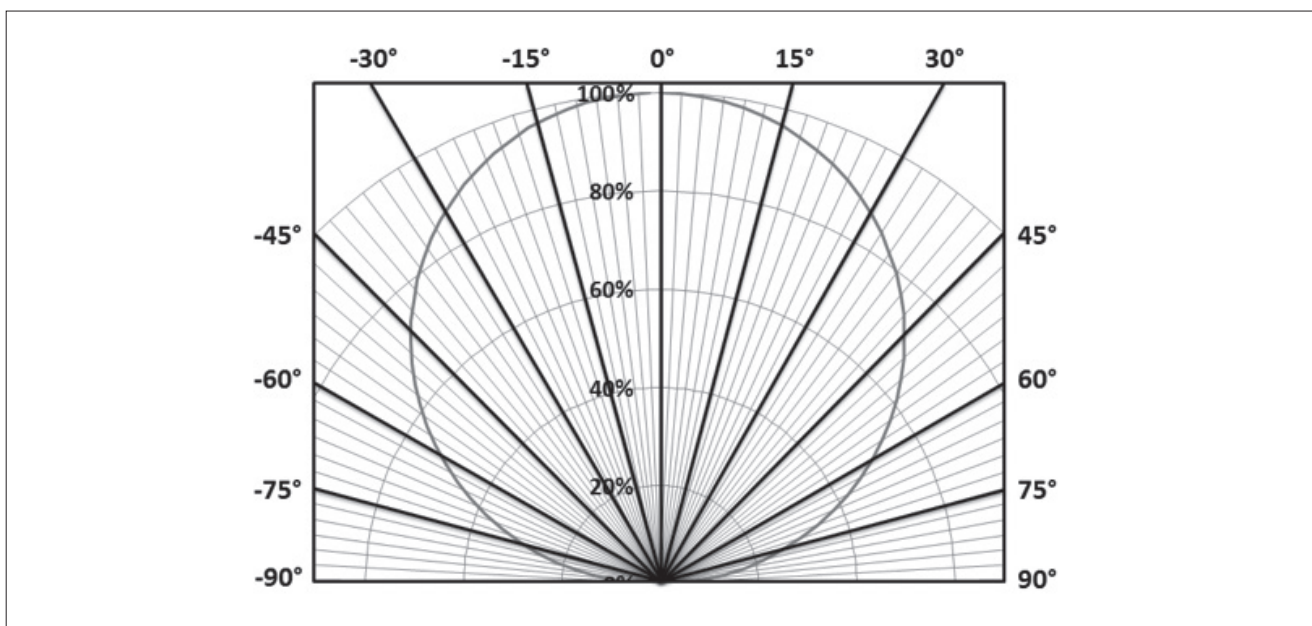

# Typical Color Spectrum

Figure 12: Typical Color Spectrum

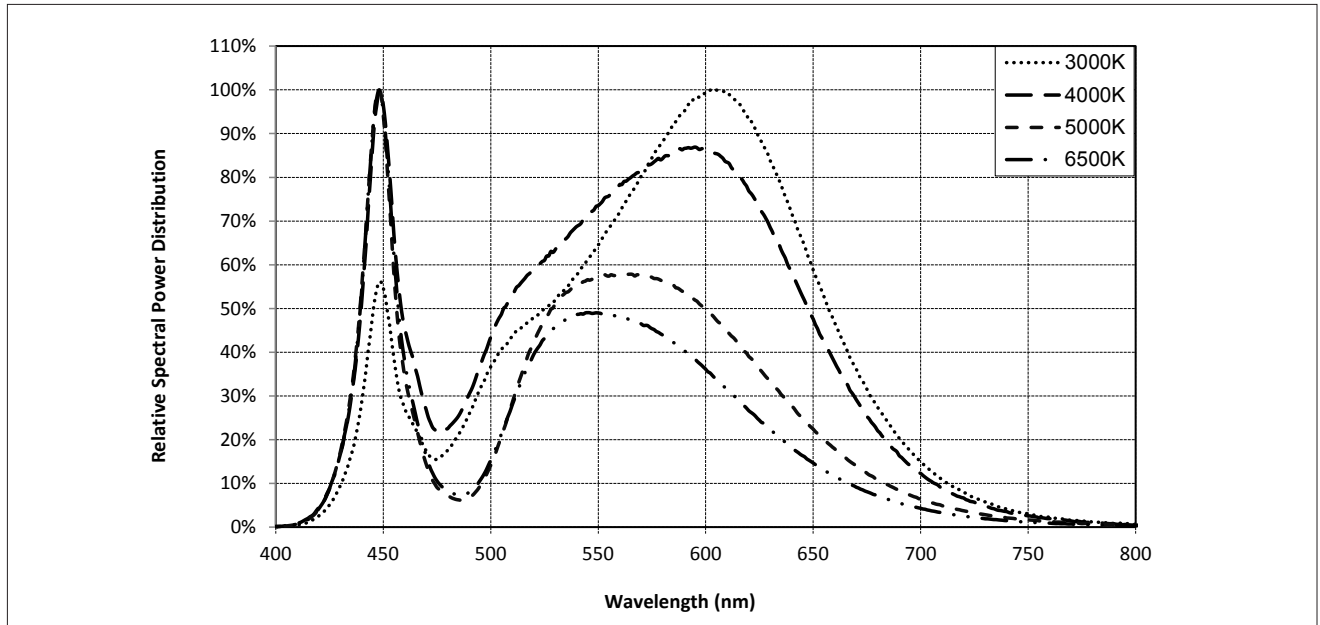

Notes for Figure 12:

1. Color spectra measured at nominal current for  $T_j = T_c = 25^\circ\text{C}$ .
2. Color spectra shown is 3000K and 80 CRI.
3. Color spectra shown is 4000K and 80 CRI.
4. Color spectra shown is 5000K and 70 CRI.
4. Color spectra shown is 6500K and 70 CRI.

# Mechanical Dimensions

Figure 13: Drawing for Vero 10 LED Array

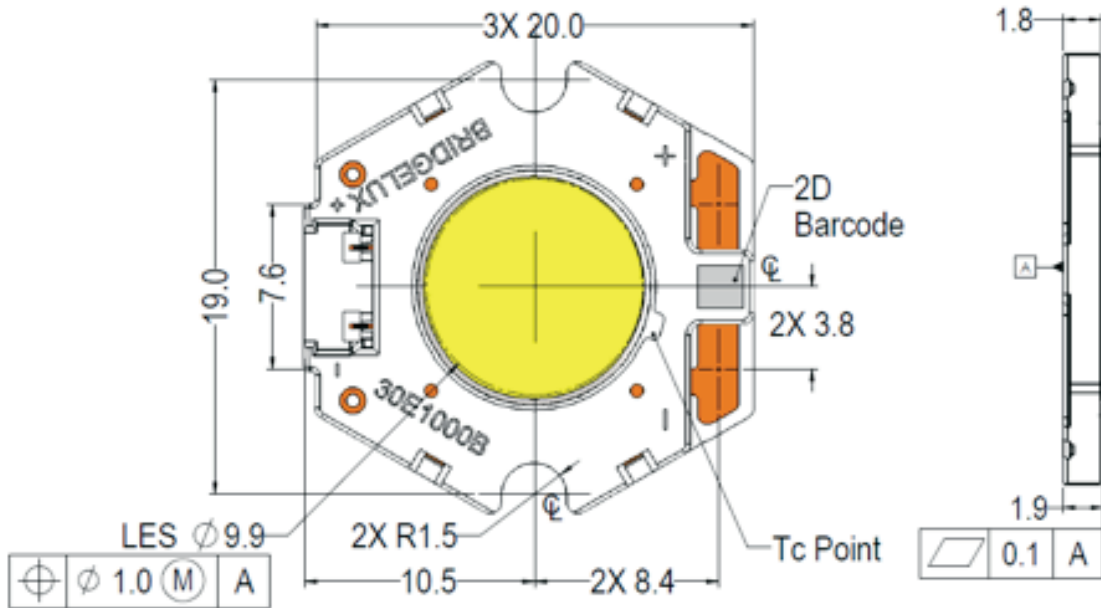

Notes for Figure 13:

1. Drawings are not to scale.
2. Dimensions are in mm.
3. Unless otherwise specified, tolerances are  $\pm 0.10$ mm.
4. Mounting slots (2X) are for M2.5 screws.
5. Bridgelux recommends two tapped holes for mounting screws with  $19.0 \pm 0.10$ mm center-to-center spacing.
6. Screws with flat shoulders (pan, dome, button, round, truss, mushroom) provide optimal torque control. Do NOT use flat, countersink, or raised head screws.
7. Solder pads and connector port are labeled "+" and "-" to denote positive and negative, respectively.
8. It is not necessary to provide electrical connections to both the solder pads and the connector port. Either set may be used depending on application specific design requirements.
9. Refer to Application Notes AN30 and AN31 for product handling, mounting and heat sink recommendations.
10. The optical center of the LED Array is nominally defined by the mechanical center of the array to a tolerance of  $\pm 0.2$ mm.
11. Bridgelux maintains a flatness of 0.10mm across the mounting surface of the array.



# Color Binning Information

**Figure 14: Graph of Warm and Neutral White Test Bins in xy Color Space**

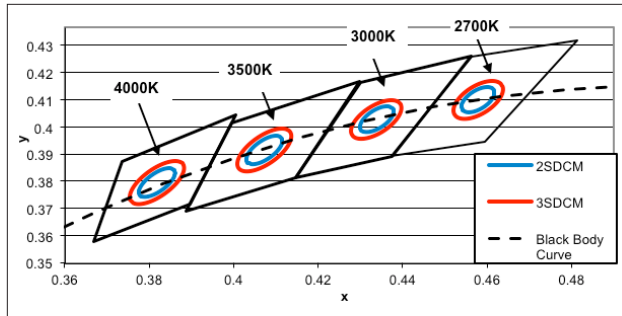

Note: Pulsed Test Conditions,  $T_c = 25^\circ\text{C}$

**Table 6: Warm and Neutral White xy Bin Coordinates and Associated Typical CCT**

Bin Code	2700K	3000K	3500K	4000K
ANSI Bin (for reference only)	(2580K - 2870K)	(2870K - 3220K)	(3220K - 3710K)	(3710K - 4260K)
23 (3 SDCM)	(2651K - 2794K)	(2968K - 3136K)	(3369K - 3586K)	(3851K - 4130K)
22 (2 SDCM)	(2674K - 2769K)	(2995K - 3107K)	(3404K - 3548K)	(3895K - 4081K)
Center Point (x,y)	(0.4578, 0.4101)	(0.4338, 0.403)	(0.4073, 0.3917)	(0.3818, 0.3797)

**Figure 15: Graph of Cool White Test Bins in xy Color Space**

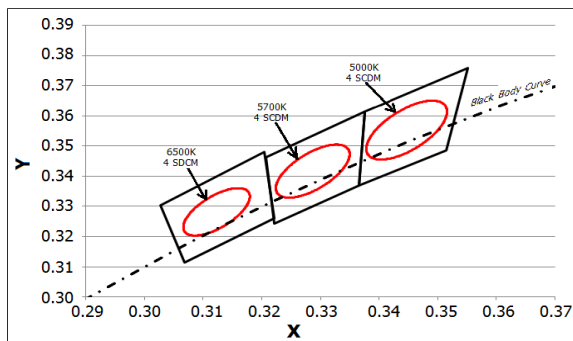

Note: Pulsed Test Conditions,  $T_c = 25^\circ\text{C}$

**Table 7: Cool White xy Bin Coordinates and Associated Typical CCT (product is hot targeted to  $T_c = 85^\circ\text{C}$ )**

Bin Code	5000K	5700K	6500K
ANSI Bin (for reference only)	(4745K - 5311K)	(5312K - 6022K)	(6022K - 7042K)
4 (4 SDCM)	(4801K - 5282K)	(5829K - 5481K)	(6270K - 6765K)
Center Point (x,y)	(0.3447, 0.3553)	(0.3287, 0.3417)	(0.3123, 0.3282)

# Packaging and Labeling

Figure 16: Drawing for Vero 10 Packaging Tray

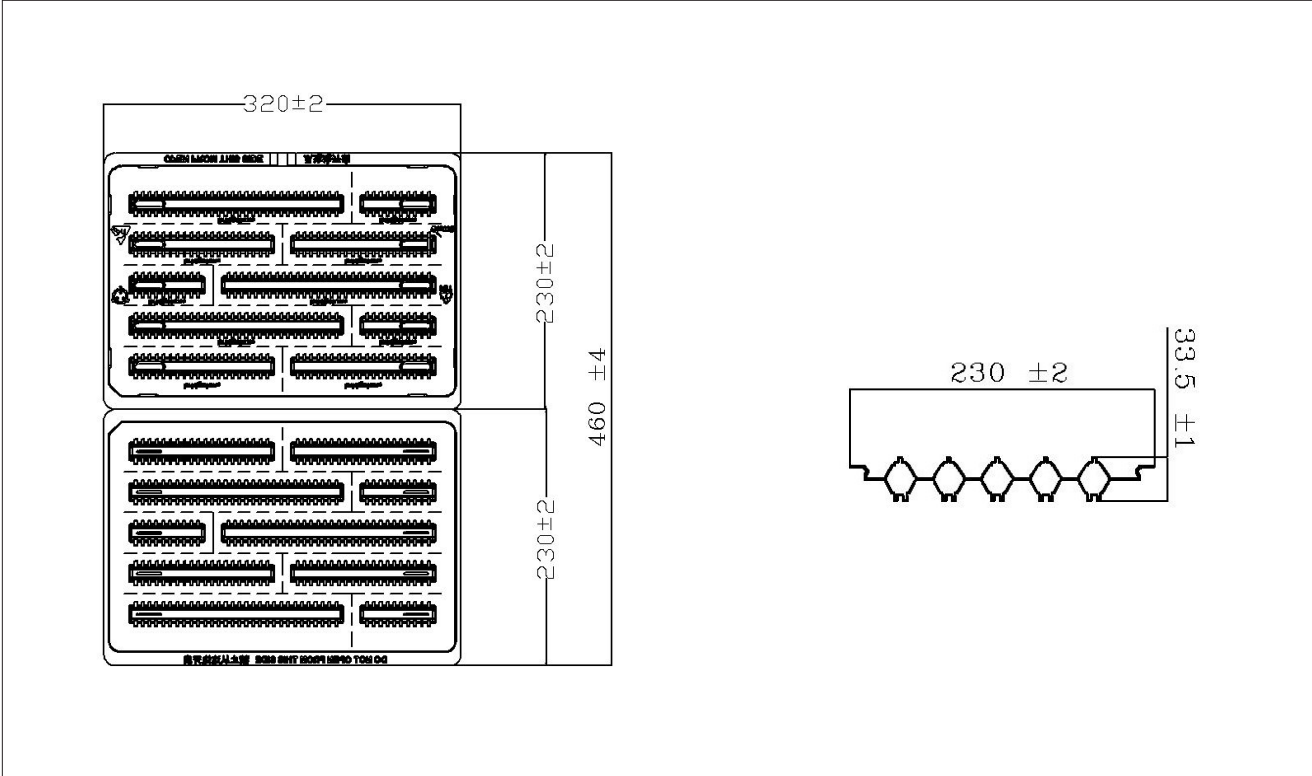

- Notes for Figure 16:
- 1. Dimensions are in millimeters.
  - 2. Drawings are not to scale.

# Packaging and Labeling

**Figure 17: Vero Series Packaging and Labeling**

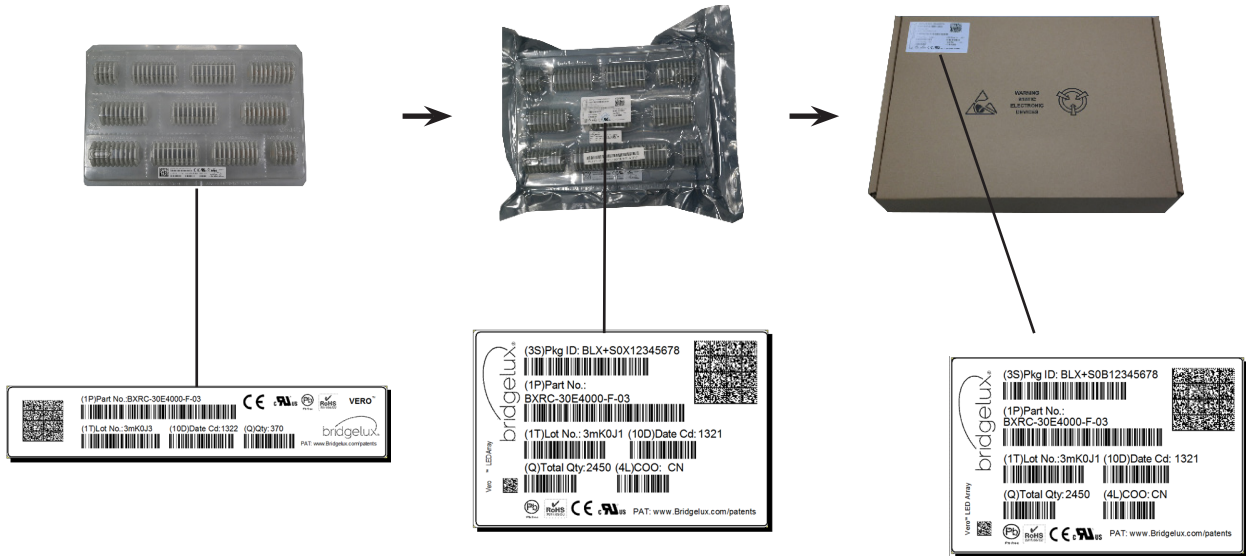

Notes for Figure 17:

1. Each tray holds 200 COBs.
2. Each tray is vacuum sealed in an anti-static bag and placed in its own box.
3. Each tray, bag and box is to be labeled as shown above.

**Figure 18: Gen. 7 Product Labeling**

Bridgelux COB arrays have laser markings on the back side of the substrate to help with product identification. In addition to the product identification markings, Bridgelux COB arrays also contain markings for internal Bridgelux manufacturing use only. The image below shows which markings are for customer use and which ones are for Bridgelux internal use only. The Bridgelux internal manufacturing markings are subject to change without notice, however these will not impact the form, function or performance of the COB array.



# Design Resources

## Application Notes

Bridgelux has developed a comprehensive set of application notes and design resources to assist customers in successfully designing with the Vero product family of LED array products. For all available application notes visit [www.bridgelux.com](http://www.bridgelux.com).

## Optical Source Models

Optical source models and ray set files are available for all Bridgelux products. For a list of available formats, visit [www.bridgelux.com](http://www.bridgelux.com).

## 3D CAD Models

Three dimensional CAD models depicting the product outline of all Bridgelux Vero LED arrays are available in both IGS and STEP formats. Please contact your Bridgelux sales representative for assistance.

## LM80

LM80 testing is on going. Please contact your Bridgelux sales representative for more information.

# Precautions

## CAUTION: CHEMICAL EXPOSURE HAZARD

Exposure to some chemicals commonly used in luminaire manufacturing and assembly can cause damage to the LED array. Please consult Bridgelux Application Note AN31 for additional information.

## CAUTION: EYE SAFETY

Eye safety classification for the use of Bridgelux Vero Series LED arrays is in accordance with specification IEC/TR 62778: Application of IEC 62471 for the assessment of blue light hazard to light sources and luminaires. Vero Series LED arrays are classified as Risk Group 2 (Moderate Risk) when operated at or below 2.5 times the nominal drive current. The Ethr value is 889.79 lux per IEC/TR 62778. Please use appropriate precautions. **Under many operating conditions the Vero Series LED arrays are classified as Risk Group 1, for more information please contact your Bridgelux sales representative.** It is important that employees working with LEDs are trained to use them safely.

## CAUTION: RISK OF BURN

Do not touch the Vero LED array during operation. Allow the array to cool for a sufficient period of time before handling. The Vero LED array may reach elevated temperatures such that could burn skin when touched

## CAUTION

### CONTACT WITH LIGHT EMITTING SURFACE (LES)

Avoid any contact with the LES. Do not touch the LES of the LED array or apply stress to the LES (yellow phosphor resin area). Contact may cause damage to the LED array.

Optics and reflectors must not be mounted in contact with the LES (yellow phosphor resin area). Optical devices may be mounted on the top surface of the plastic housing of the Vero LED array. Use the mechanical features of the LED array housing, edges and/or mounting holes to locate and secure optical devices as needed.

# Disclaimers

## MINOR PRODUCT CHANGE POLICY

The rigorous qualification testing on products offered by Bridgelux provides performance assurance. Slight cosmetic changes that do not affect form, fit, or function may occur as Bridgelux continues product optimization.

## STANDARD TEST CONDITIONS

Unless otherwise stated, array testing is performed at the nominal drive current.

# About Bridgelux: We Build Light That Transforms

At Bridgelux, we help companies, industries and people experience the power and possibility of light. Since 2002, we've designed LED solutions that are high performing, energy efficient, cost effective and easy to integrate. Our focus is on light's impact on human behavior, delivering products that create better environments, experiences and returns—both experiential and financial. And our patented technology drives new platforms for commercial and industrial luminaires.

**For more information about the company, please visit**  
**bridgelux.com**  
**twitter.com/Bridgelux**  
**facebook.com/Bridgelux**  
**WeChat ID: BridgeluxInChina**



101 Portola Avenue  
Livermore, CA 94551  
Tel (925) 583-8400  
Fax (925) 583-8410  
[www.bridgelux.com](http://www.bridgelux.com)

© 2016 Bridgelux, Inc. All rights reserved 2016. Product specifications are subject to change without notice. Bridgelux, the Bridgelux stylized logo design and Vero are registered trademarks, and Decor Series is a trademark of Bridgelux, Inc. All other trademarks are the property of their respective owners.

Bridgelux Gen 7 Vero 10 Array Series Product Data Sheet DS90 Rev. C (07/2016)