

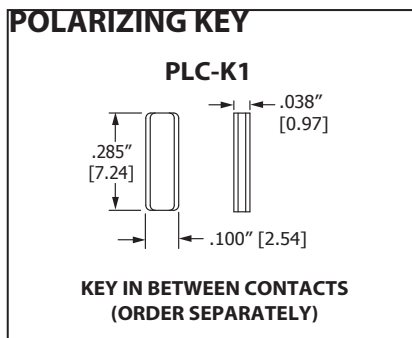

.125" [3.18 mm] Contact Centers, .610" [15.49 mm] Insulator Height, Dip Solder/Wire Wrap/Right Angle

SPECIFICATIONS

- Accommodates $.062" \pm .008"$ [1.57 mm \pm 0.20 mm] PC board (See following pages for $.093" \pm .008"$ [2.36 mm \pm 0.20 mm] and $.125" \pm .008"$ [3.18 mm \pm 0.20 mm] mating PCB)
- PBT, PPS or PA9T insulator
- Molded-in key available
- 3 Amps current rating for one contact energized
- 30 milli Ohms maximum at rated current
- UL Flammability Rating: 94V-0

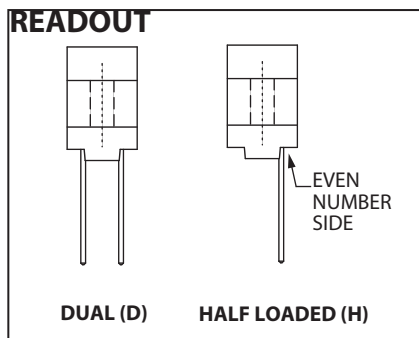
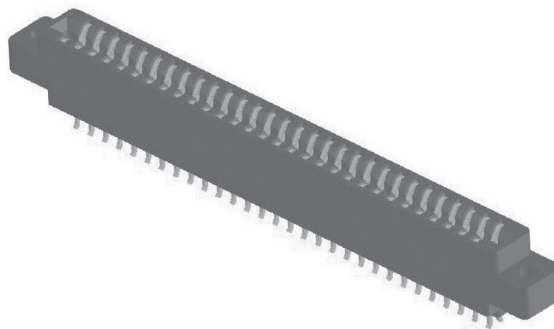

TERMINATION TYPE

HAIRPIN BELLOWS

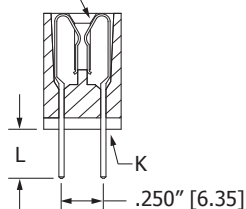

HAIRPIN BELLOWS (CS,CM,CW,CT)

LOOP BELLOWS

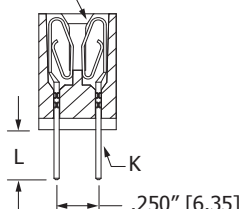

LOOP BELLOWS (TK,RS,RM,CK)

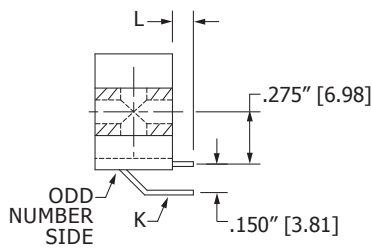

RIGHT ANGLE, DIP SOLDER (CA,CB,CC,TA,TB,TM)

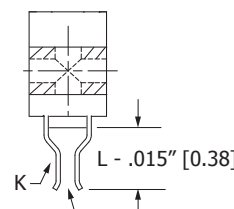

CARD EXTENDER REQUIRES -S288 MODIFICATION CODE (CS,CM,CT,RS,CK,TK,RM)

HAIRPIN BELLOWS	LOOP BELLOWS	TERMINATION TYPE	POST CROSS SECTION K	POST LENGTH L \pm .025" [0.64]	FITS MIN. HOLE SIZE
	TK, CK	DIP SOLDER	.025" [0.64] ROUND	.190" [4.83]	.033" [0.84]
	RS	DIP SOLDER	.025" [0.64] SQUARE	.190" [4.83]	.040" [1.02]
CM	RM	WIRE WRAP	.025" [0.64] SQUARE	.560" [14.20]	.040" [1.02]
CA	TA	RIGHT ANGLE	.025" [0.64] SQUARE	.100" [2.54]	.043" [1.09]
CB	TB	RIGHT ANGLE	.025" [0.64] SQUARE	.180" [4.57]	.043" [1.09]
CC	TM	RIGHT ANGLE	.025" [0.64] SQUARE	.250" [6.35]	.043" [1.09]
CW		DIP SOLDER	.015" X .025" [0.38 X 0.64]	.125" [3.18]	.035" [0.89]
CT		DIP SOLDER	.015" X .025" [0.38 X 0.64]	.170" [4.32]	.035" [0.89]
CS		DIP SOLDER	.025" [0.64] SQUARE	.160" [4.06]	.040" [1.02]

MOUNTING STYLE

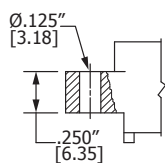

CLEARANCE HOLE (H)

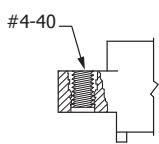

THREADED INSERT (I)

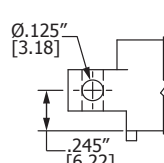

SIDE MOUNTING (S)



NO MOUNTING EARS (N)

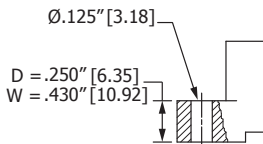

FLUSH MOUNTING (D, W)

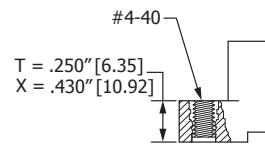

FLUSH MOUNTING WITH THREADED INSERT (T, X)



.125" [3.18 mm] Contact Centers, .610" [15.49 mm] Insulator Height, Dip Solder/Wire Wrap/Right Angle

PART NUMBER OPTIONS

MATERIALS (INSULATOR/CONTACT)

- E = PBT/Phosphor Bronze (Standard)
 - R = PPS/Phosphor Bronze
 - G = PA9T/Phosphor Bronze
 - H = PBT/Beryllium Copper
 - A = PPS/Beryllium Copper
 - J = PA9T/Beryllium Copper
- (Consult factory for other materials.)
Refer to Page 7 for Operating/Processing Temperatures

CONTACT FINISH - RoHS Compliant

- All platings are Lead Free and have .000050" Nickel underplate
- | Contact Surface | Termination |
|------------------------------|--------------------------|
| B = .000010" Gold | .000100" Pure Tin, Matte |
| C = .000030" Gold | .000100" Pure Tin, Matte |
| G = .000010" Gold | .000005" Gold |
| Y = .000030" Gold | .000005" Gold |
| Contact Surface | Overall Plating |
| S = .000010" Gold | .000010" Gold |
| M = .000030" Gold | .000010" Gold |
| E = .000100" Pure Tin, Matte | .000100" Pure Tin, Matte |

CONTACT CENTERS

- A = .125" [3.18 mm]

NUMBER OF CONTACT POSITIONS

See Chart Below

READOUT (Opposite Page)

- D = Dual
- H = Half Loaded

E B A 50 D CM H - Sxxx

MODIFICATION CODE (Consult Factory)

OMIT FOR STANDARD

-S288 = Card Extender Accepts .062" [1.57 mm] PCB

MOUNTING STYLE (Opposite Page)

- H = Clearance Holes
- I = Threaded Inserts
- S = Side Mounting
- N = No Mounting
- W = Flush Mounting
- D = Flush Mounting
- X = Flush Mounting with Threaded Inserts
- T = Flush Mounting with Threaded Inserts

TERMINATION TYPE (Opposite Page)

Hairpin Bellows **

**Available with B or C plating and Phosphor Bronze Only

- CS = .025" [0.64 mm] Square Dip Solder
- CM = .025" [0.64 mm] Square Wire Wrap
- CA, CB, CC = .025" [0.64 mm] Square Right Angle
- CW, CT = .015" X .025" [0.38 mm X 0.64 mm] Dip Solder

Loop Bellows

- RS = .025" [0.64 mm] Square Dip Solder
- CK, TK = .025" [0.64 mm] Round Dip Solder
- RM = .025" [0.64 mm] Square Wire Wrap
- TA, TB, TM = .025" [0.64 mm] Square Right Angle

DIMENSIONS Dimensions in [] are in millimeters, all others are in inches.

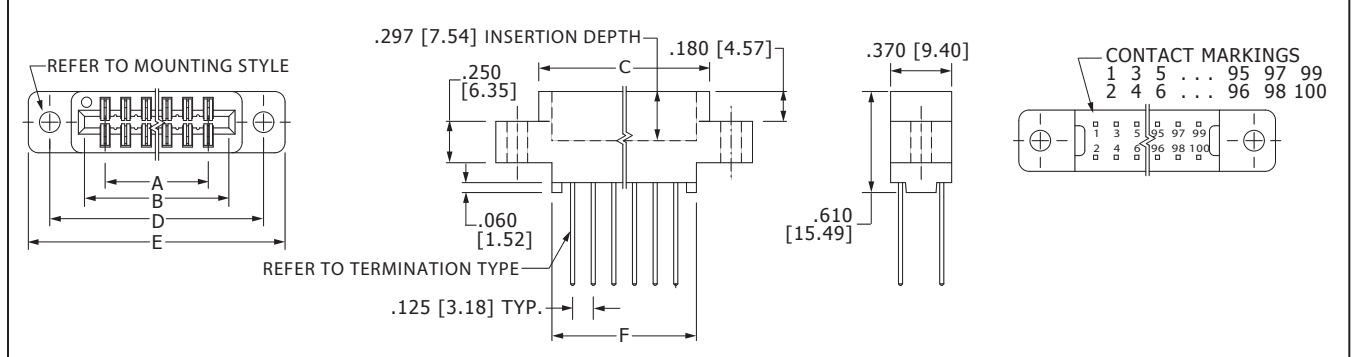

Tolerances on non-critical dimensions may vary slightly due to shrinkage differential per insulator material; Consult factory.

POSITIONS/ CONTACTS	INCHES						MILLIMETERS					
	A±.008	B±.008	C±.015	D±.010	E±.020	F±.015	A±0.20	B±0.20	C±0.38	D±0.25	E±0.51	F±0.38
06/12	0.625	0.875	1.035	1.295	1.555	0.875	15.88	22.23	26.29	32.89	39.50	22.23
10/20	1.125	1.375	1.535	1.795	2.055	1.375	28.58	34.93	38.99	45.59	52.20	34.93
14/28	1.625	1.875	2.035	2.295	2.555	1.875	41.28	47.63	51.69	58.29	64.90	47.63
15/30	1.750	2.000	2.160	2.420	2.680	2.000	44.45	50.80	54.86	61.47	68.07	50.80
18/36	2.125	2.375	2.535	2.795	3.055	2.375	53.98	60.33	64.39	70.99	77.60	60.33
22/44	2.625	2.875	3.035	3.295	3.555	2.875	66.68	73.03	77.09	83.69	90.30	73.03
24/48	2.875	3.125	3.285	3.545	3.805	3.125	73.03	79.38	83.44	90.04	96.65	79.38
25/50*	3.000	3.250	3.410	3.670	3.930	3.250	76.20	82.55	86.61	93.22	99.82	82.55
28/56	3.375	3.625	3.785	4.045	4.305	3.625	85.73	92.08	96.14	102.74	109.35	92.08
30/60	3.625	3.875	4.035	4.295	4.555	3.875	92.08	98.43	102.49	109.09	115.70	98.43
31/62	3.750	4.000	4.160	4.420	4.680	4.000	95.25	101.60	105.66	112.27	118.87	101.60
32/64	3.875	4.125	4.285	4.545	4.805	4.125	98.43	104.78	108.84	115.44	122.05	104.78
35/70	4.250	4.500	4.660	4.920	5.180	4.500	107.95	114.30	118.36	124.97	131.57	114.30
36/72	4.375	4.625	4.785	5.045	5.305	4.625	111.13	117.48	121.54	128.14	134.75	117.48
40/80	4.875	5.125	5.285	5.545	5.805	5.125	123.83	130.18	134.24	140.84	147.45	130.18
43/86	5.250	5.500	5.660	5.920	6.180	5.500	133.35	139.70	143.76	150.37	156.97	139.70
44/88	5.375	5.625	5.785	6.045	6.305	5.625	136.53	142.88	146.94	153.54	160.15	142.88
49/98	6.000	6.250	6.410	6.670	6.930	6.250	152.40	158.75	162.81	169.42	176.02	158.75
50/100	6.125	6.375	6.535	6.795	7.055	6.375	155.58	161.93	165.99	172.59	179.20	161.93

* Consult factory for availability.