

# RJ45 10/100 Base-T Jack with Magnetic Module

ARJ11G

RoHS  
Compliant



16.26 x 13.84 x 21.59mm

## FEATURES:

- Available with or without LED
- Suitable CAT 5 & 6 cable and UTP
- Comply IEEE 802.3ab
- LAN Magnetic with RJ4
- Suitable for RoHS compliant reflow

## APPLICATIONS:

- 10/100 Base-T LAN
- NIC, LoM and PC

## STANDARD SPECIFICATIONS at 25°C

Operating temperature range: 0°C to +70°C Storage temperature range: -40°C to +85°C

Part Number	Turns Ratio ± 5%		EMI Fingers	LEDs L/R	Insertion Loss (dB max) 0.3- 100 MHz	Return Loss (dB MIN @100Ω±15Ω)			
	TX	RX				1- 30 MHz	40 MHz	50 MHz	60 – 80 MHz
ARJ11G-MASA-A-B-ELT2	1CT:1	1CT:1	No	G/Y	-1	-20	-15	-15	-10
ARJ11G-MASA-A-B-FLT2	1CT:1	1CT:1	No	G/Y	-1	-20	-15	-15	-10
ARJ11G-MBSB-MU2	1CT:1CT	1CT:1CT	No	N/A	-1	-18	-16	-14	-12
ARJ11G-MBSC-MU2	1CT:1CT	1CT:1CT	No	N/A	-1	-18	-16	-14	-12
ARJ11G-MBSD-LU2	1CT:1	1CT:1CT	No	N/A	-1	-18	-16	-14	-12
ARJ11G-MBSE-MU2	1CT:1CT	1CT:1CT	No	N/A	-1	-18	-16	-12	-10

Part Number	Crosstalk (dB TYP)			Common Mode Rejection (dB MIN)			DCR (MAX Ω)		Hipot (Vrms)
	30 MHz	60 MHz	100 MHz	30 MHz	60 MHz	100 MHz	PRI	SEC	
ARJ11G-MASA-A-B-ELT2	-30	-30	-30	-30	-30	-30	1.0	1.2	1000
ARJ11G-MASA-A-B-FLT2	-30	-30	-30	-30	-30	-30	1.0	1.2	1000
ARJ11G-MBSB-MU2	-45	-40	-35	-35	-30	-25	-	-	1500
ARJ11G-MBSC-MU2	-45	-40	-35	-35	-30	-25	-	-	1500
ARJ11G-MBSD-LU2	-45	-40	-35	-35	-30	-25	-	-	1500
ARJ11G-MBSE-MU2	-40	-35	-30	-30	-20	-20	-	-	1500

Contact Abracon for more custom configurations. See options to build a custom configuration.

## OPTIONS AND PART IDENTIFICATION

ARJ11G - [ ] [ ] - [ ] - [ ] - [ ] [ ] [ ] [ ]

Mechanical	Schematic	Left LED color (e.g. B for Yellow, AB for Green-Yellow)	Right LED color (e.g. B for Yellow, AB for Green-Yellow)	LED polarity	Turns Ratio (Tx)	Turns Ratio (Rx)	Gold plating
MA, MB <small>(Please see mechanical section)</small>	SA ~ SE <small>(Please see schematic section)</small>	Blank: No LED A: Green B: Yellow C: Amber D: Orange	Blank: No LED A: Green B: Yellow C: Amber D: Orange	Blank: No LED E, F <small>(Please see 7.0 LED polarity section)</small>	K: 1CT:1.41 L: 1CT:1 M: 1CT:1CT N: 1.414:1CT O: 1CT:1.41CT P: 1:2CT Q: 1:1.414CT R: 1CT:2.5	S: 1CT:1.41 T: 1CT:1 U: 1CT:1CT V: 1.414:1CT W: 1CT:1.41CT X: 1:2CT Y: 1:1.414CT Z: 1CT:2.5	1: 3u “ 2: 6u “ 3: 15u “ 4: 30u “ 5: 50u “

ABRACON IS  
ISO 9001:2008  
CERTIFIED



**ABRACON**  
CORPORATION

Visit [www.abracon.com](http://www.abracon.com) for Terms & Conditions of Sale  
30332 Esperanza, Rancho Santa Margarita, California 92688  
tel 949-546-8000 | fax 949-546-8001 | [www.abracon.com](http://www.abracon.com)

Revised: 05.08.11

# RJ45 10/100 Base-T Jack with Magnetic Module

ARJ11G

RoHS  
Compliant



16.26 x 13.84 x 21.59mm

## MECHANICAL DIMENSIONS

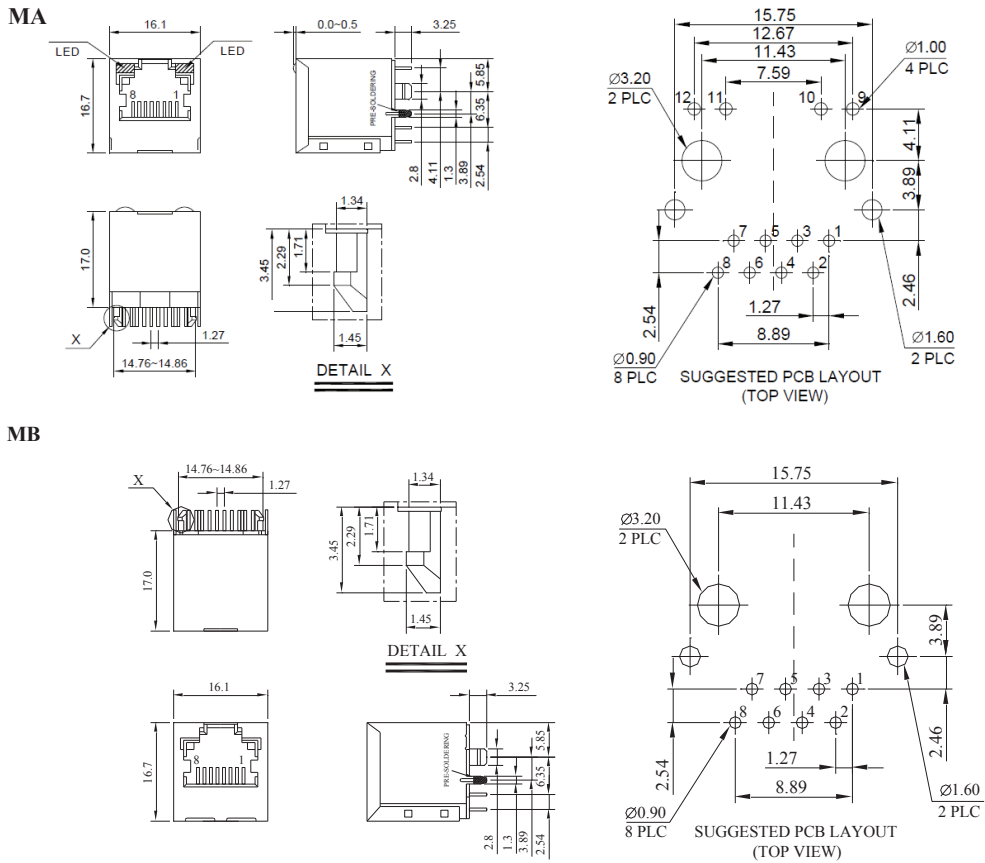

## SCHEMATICS

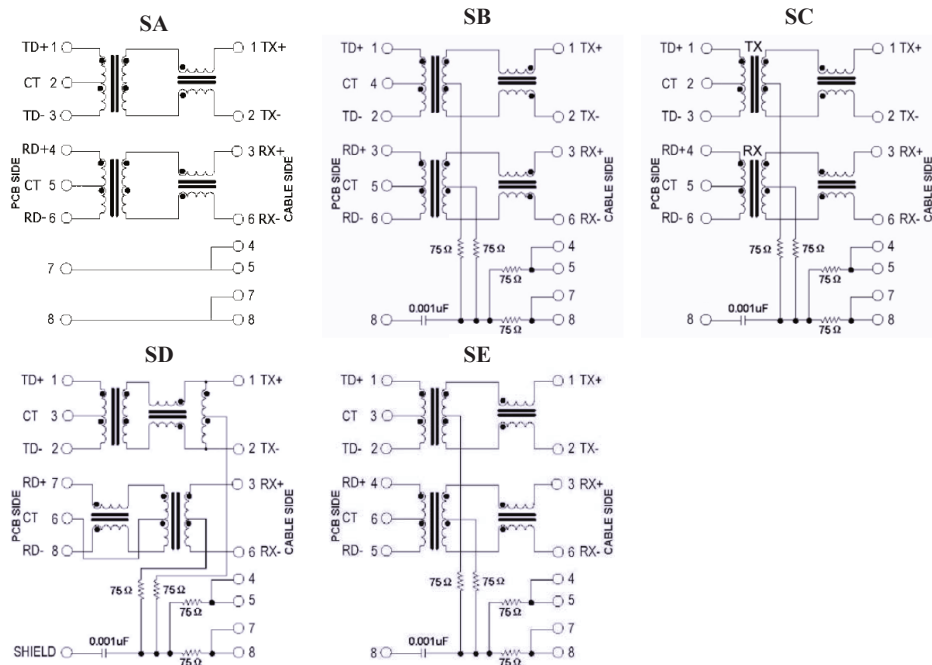

ABRACON IS  
ISO 9001:2008  
CERTIFIED

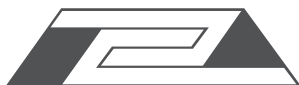

**ABRACON**  
CORPORATION

Visit [www.abracon.com](http://www.abracon.com) for Terms & Conditions of Sale  
30332 Esperanza, Rancho Santa Margarita, California 92688  
tel 949-546-8000 | fax 949-546-8001 | [www.abracon.com](http://www.abracon.com)

Revised: 05.08.11

# RJ45 10/100 Base-T Jack with Magnetic Module

ARJ11G

RoHS  
Compliant



16.26 x 13.84 x 21.59mm

## LED POLARITY

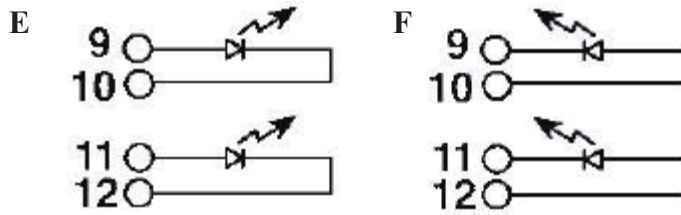

## PACKING: 60pcs/tray

Packaging material: PET

Outer carton unit 1320 pcs/ 22 Trays/box

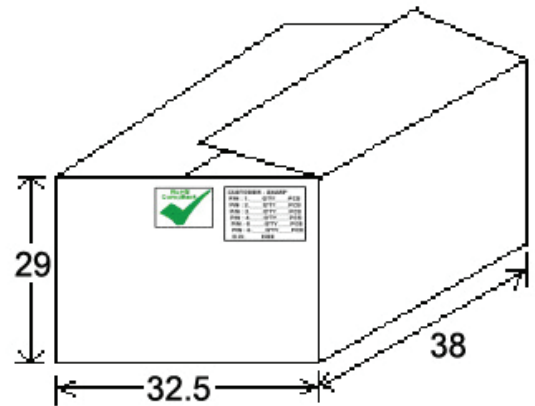
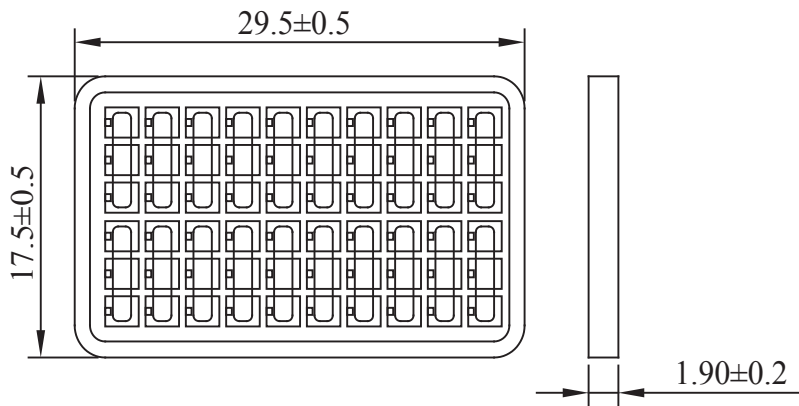

## REFLOW PROFILE:

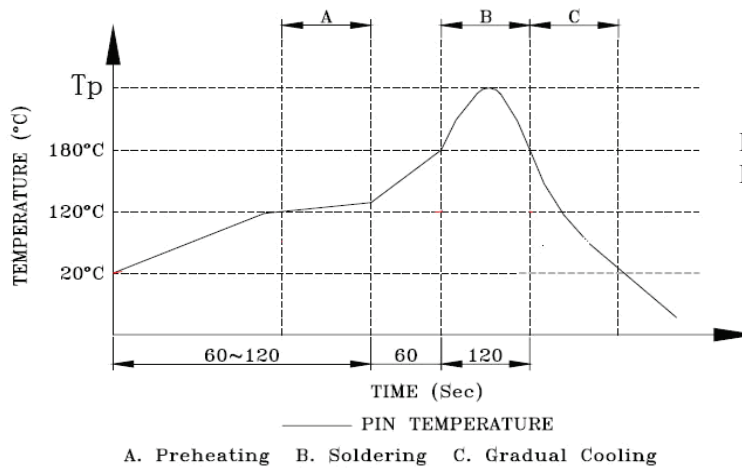

**ATTENTION:** Abracon Corporation's products are COTS – Commercial-Off-The-Shelf products; suitable for Commercial, Industrial and, where designated, Automotive Applications. Abracon's products are not specifically designed for Military, Aviation, Aerospace, Life-dependant Medical applications or any application requiring high reliability where component failure could result in loss of life and/or property. For applications requiring high reliability and/or presenting an extreme operating environment, written consent and authorization from Abracon Corporation is required. Please contact Abracon Corporation for more information.

ABRACON IS  
ISO 9001:2008  
CERTIFIED



**ABRACON**  
CORPORATION

Visit [www.abracon.com](http://www.abracon.com) for Terms & Conditions of Sale  
30332 Esperanza, Rancho Santa Margarita, California 92688  
tel 949-546-8000 | fax 949-546-8001 | [www.abracon.com](http://www.abracon.com)

Revised: 05.08.11